

FEDERAL LOCK



CATALOG



2023

Padlock

FEDERAL LOCK

YOUR SAFETY IS OUR PRIORITY COUNT ON FEDERAL NO MORE TROUBLE

FEDERAL LOCK has gained proud results in past 50 years : our products and the self-owned brand -FEDERAL LOCK renowned domestically and abroad, made trademark registered in 36 countries, the certification by ISO 9001, research and development constantly of innovation and upgrade on products, production scale also continued improving and diligent. By international OEM and ODM to connect with international standards, and gained the recognition and trust by many large distributors in the world. Thus we have established a constant co-prosperity and solid relations with customers and suppliers, and have a world class research and development and manufacturing capabilities, Products have passed the most stringent world standard test (United States ASTM 883 GRADE fifth / sixth, United Kingdom SOLD SECURE, EUROPROFILE CYLINDER DIAMOND GRADE and PADLOCK GOLD GRADE)





741

**FEDERAL
LOCK**

FEDERAL
LOCK

18505
FEDERAL



CONTENT

Combination Padlock

• Shackleless Padlock	7
• Weatherproof & JR Cover	8
• Hardened Steel Padlock	10
• Brass Padlock	12
• Zinc Padlock	14
• Laminated Padlock	15
• Luggage Padlock	17

SFIC Series

• SFIC Core	25
• Shackleless Padlock	26
• Weatherproof & JR Cover	27
• Solid Steel Padlock	28
• Solid Brass Padlock	29
• Stainless Steel Padlock	33
• Stainless Steel JR cover Padlock	34
• Solid Steel Round Padlock	35
• Solid Steel Square Padlock	36
• Solid Brass Square Padlock	37
• Solid Aluminum Padlock	38
• Solid Aluminum JR Cover	39

LFIC Series

• Shackleless Padlock	42
• Solid Steel Padlock	44
• Solid Brass Padlock	45
• Stainless Steel Padlock	50

KIK Series

• KIK Core	53
• Shackleless Padlock	54
• Solid Brass Padlock	56
• Solid Steel Padlock	61
• Stainless Steel Padlock	62
• Solid Steel Round Padlock	63



AUNZ Series

• AUNZ Core	67
• Shackless Padlock	68
• Solid Steel Padlock	69
• Solid Brass Padlock	73
• Stainless Steel Padlock	74
• Solid Steel Rectangular Padlock	75
• Solid Steel Round Padlock	76

CA6CK Series

• CA6CK Core	80
• Shackleless Padlock	81
• Solid Steel Rectangular Padlock	82
• Solid Steel Round Padlock	83
• Solid Steel Padlock	86
• Brass Padlock	88
• Aluminum Padlock	94
• A Plus Padlock	99
• Stainless Padlock	101

Euro Profile Padlock

• Solid Steel Padlock	103
• Solid Brass Padlock	106
• Solid Steel Rectangular Padlock	112

Non -rekeyable Padlock

• Solid Brass Padlock	114
• Rectangular Solid Brass Padlock	122
• US32D Padlock	123
• US26D Padlock	125
• A Plus Padlock	126
• Laminated Padlock	127
• Shielded shackle padlock	133

Safety lockout Padlock

• PL90	135
• PL90PE	136
• SLH Series	137

Tool Box & Pinning kit

• PL90	138
• TB05	140



COMBINATION PADLOCK

Convenient, safe.
No matter what your purpose is.
Our combination padlock is your best companions

SR400



Description V

A shackleless resettable combination solid steel padlock combined with number dials device for lock opening to provide confidential security & JR cover to have advanced protection and suitable for hasp, such as 2025,3035,4040,4050 or 4060 to extend the range of application, also the applicable place. The advantage provided corrosion and wear resistance by chrome plated finish on the lock face.

Features V

- Solid steel lock body with US26D plating
- Patented anti-dust (JR) cover
- Hardened steel bolt with quality plating
- Combined with the popular types of hasp to sliding or swinging door security.
- 4 dials with 10,000 possible combinations
- Easy to reset your combination numbers at any time.
- Keyless convenience
- Change Code Pin from the key hole

▼SR400

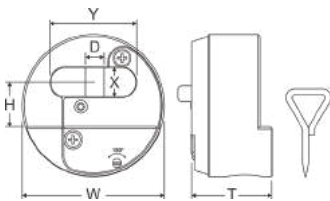

▼SR401

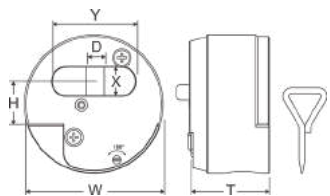

▲Anti-dust cover



Item #	DIMENSION(MM)						
	Lock Body			Shackle			Dial
	W	H	T	D	X	Y	
(1) Step Back							
SR400	73	23	42	10.2	15	44	4
(2) Flat Back							
SR401	73	23	42	10.2	15	44	4

CYLINDER
DOOR & WINDOW LOCK
CABINET & DRAWER LOCK
PADLOCK
OTHER
PINNING & TOOLBOX
KEYBLANK

COMBINATION Weatherproof & JR



SR60W/JR



Description V

A new weatherproof & JR cover resettable combination padlock combined with number dials device for lock opening to provide confidential security.

Features V

- Hardened Steel lock case with weather proof cover.
- Patented anti-dust(JR) cover.
- Anti-cut molybdenum shackle.
- 4 dials with 10,000 possible combinations.
- Easy to reset with your combination number at any time.
- Keyless convenience.

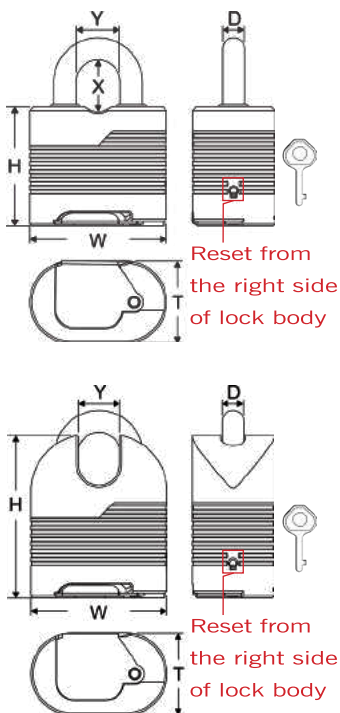

▲Anti-dust cover



Item #	DIMENSION(MM)						
	Lock Body			Shackle			Dial
	W	H	T	D	X	Y	
SR60W/JR	69	60	41	11.1	26	22	4
SR62W/JR	69	60	41	11.1	52	22	4
Shrouded Shackle							
SR60PW/JR	69	82	41	11.1	27	21	4

SRB50W/JR

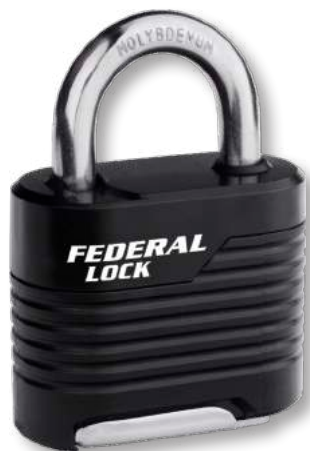

Description V

A new weatherproof & JR cover resettable combination padlock combined with number dials device for lock opening to provide confidential security.

Features V

- Weather Proof cover.
- Patented anti-dust(JR) cover.
- Anti-cut molybdenum shackle
- 4 dials with 10,000 possible combinations
- Easy to reset with your combination number at any time.
- Keyless convenience.

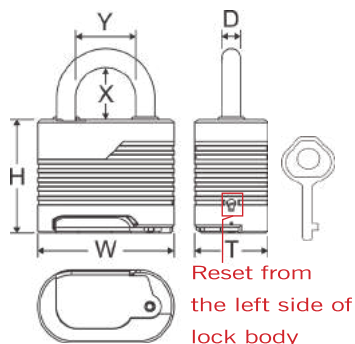

▲Anti-dust cover



Item #	DIMENSION(MM)						
	Lock Body			Shackle			Dial
	W	H	T	D	X	Y	
SRB50W/JR	57	48	31	7.9	23	25	4
SRB52W/JR	57	48	31	7.9	48	25	4

CYLINDER

DOOR & WINDOW LOCK

CABINET & DRAWER LOCK

PADLOCK

OTHER

PINNING & TOOLBOX

KEYBLANK

COMBINATION Hardened steel



SR60



Description V

An extra heavy duty resettable combination steel padlock combined with number dials device for lock opening to provide confidential security.

Features V

- Hardened steel lock case against damage to surface.
- Quality e-coating and internal anti-corrosion components.
- Anti-cut molybdenum shackle.
- 4 dials with 10,000 possible combinations.
- Easy to reset your combination numbers at any time.
- Keyless convenience.

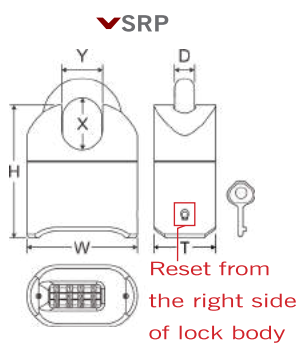
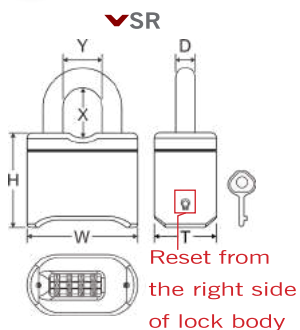

SR60



Item #	DIMENSION(MM)						
	Lock Body			Shackle			Dial
	W	H	T	D	X	Y	
SR60	62	53	35	11.1	28	22	4
SR62	62	53	35	11.1	54	22	4
Shrouded Shackle							
SR60P	62	75	35	11.1	29	22	4

NSR60



Description V

An extra heavy duty resettable combination steel padlock combined with number dials device for lock opening to provide confidential security.

Features V

- Hardened steel lock case against damage to surface.
- Quality e-coating and internal anti-corrosion components.
- Anti-cut molybdenum shackle.
- 4 dials with 10,000 possible combinations.
- Easy to reset your combination numbers at any time.
- Keyless convenience.

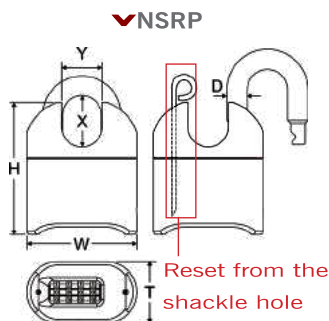
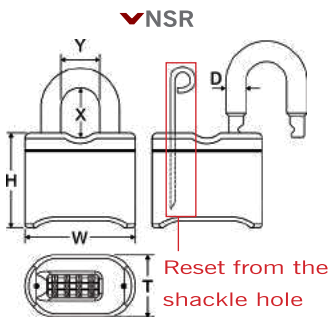

NSR60



Item #	DIMENSION(MM)						
	Lock Body			Shackle			Dial
	W	H	T	D	X	Y	
NSR60	62	53	35	11.1	28	22	4
NSR62	62	53	35	11.1	54	22	4
Shrouded Type							
NSR60P	62	75	35	11.1	29	22	4

CYLINDER
 DOOR &
 WINDOW LOCK
 CABINET &
 DRAWER LOCK
 PADLOCK
 OTHER
 PINNING &
 TOOLBOX
 KEYBLANK

COMBINATION Brass



SRB50



Description V

A resettable combination brass padlock combined with number dials device for lock opening to provide confidential security.

Features V

- Brass lock case
- Multiple shackle material options
- Shackle Seal for avoiding water sinking in
- 4 dials with 10,000 possible combinations
- Easy to reset with your combination number at any time.
- Keyless convenience

Color V

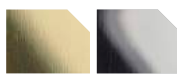

US3 US26

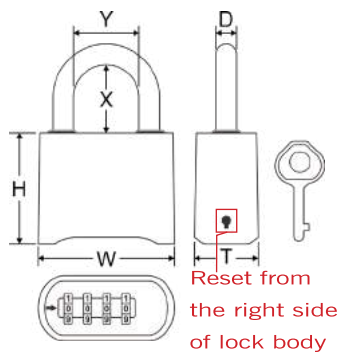

SRB50



Item #	DIMENSION(MM)						
	Lock Body			Shackle			Dial
	W	H	T	D	X	Y	
(1) Brass lock body with anti-cut molybdenum shackle							
SRB50R	52	42	25	7.9	23	25	4
SRB52R	52	42	25	7.9	49	25	4
(2) Brass lock body with brass shackle							
SRB50B	52	42	25	7.9	23	25	4
SRB52B	52	42	25	7.9	49	25	4
(3) Mirror chrome plated brass lock body with stainless steel shackle							
SRB50KS	52	42	25	7.9	23	25	4
SRB52KS	52	42	25	7.9	49	25	4

NSRB50



Description V

A resettable combination brass padlock combined with number dials device for lock opening to provide confidential security.

Features V

- Brass lock case
- Multiple shackle material options
- Shackle Seal for avoiding water sinking in
- 4 dials with 10,000 possible combinations
- Easy to reset with your combination number at any time.
- Keyless convenience

Color V

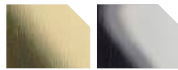

US3 US26

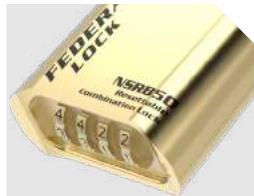
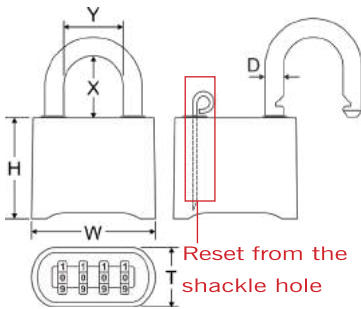

▲ NSRB50



Item #	DIMENSION(MM)						
	Lock Body			Shackle			Dial
	W	H	T	D	X	Y	
(1) Brass lock body with anti-cut molybdenum shackle							
NSRB50R	52	42	25	7.9	23	25	4
NSRB52R	52	42	25	7.9	49	25	4
(2) Brass lock body with brass shackle							
NSRB50B	52	42	25	7.9	23	25	4
NSRB52B	52	42	25	7.9	49	25	4
(3) Mirror chrome plated brass lock body with stainless steel shackle							
NSRB50KS	52	42	25	7.9	23	25	4
NSRB52KS	52	42	25	7.9	49	25	4

CYLINDER
 DOOR &
 WINDOW LOCK
 DRAWER LOCK
 CABINET &
 DRAWER LOCK
 PADLOCK
 OTHER
 PINNING &
 TOOLBOX
 KEYBLANK

COMBINATION Zinc



RB50Z



Description V

A resettable combination die-cast zinc padlock combined with number dials device for lock opening to provide confidential security.

Features V

- Die-cast zinc lock case
- Hardened shackle.
- 4 dials with 10,000 possible combinations
- Easy to reset with your combination number at any time.
- Keyless convenience
- Multiple color options for managing easily.

Color V

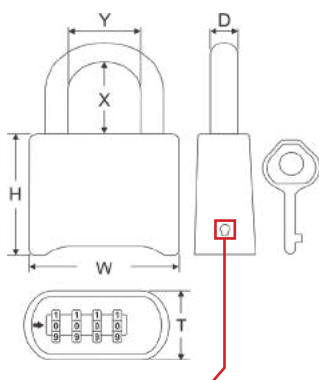

Reset from the right side of lock body



▲ RB50Z



Item #	DIMENSION(MM)						
	Lock Body			Shackle			Dial
	W	H	T	D	X	Y	
RB50Z	52	42	25	7.9	23	25	4
RB52Z	52	42	25	7.9	49	25	4

* Above items are available with many colors. Please add "color code" after the above Item#. Such as: RB50Z-BK, or RB50Z-US26

RL40W/RL46W



Description V

A resettable laminated combination brass padlock combined with number dials device for lock opening to provide confidential, economical and practical purposes.

Features V

- Laminated steel lock body with quality plating
- Hardened steel shackle
- 3 dials with 1,000 possible combinations
- 4 dials with 10,000 possible combinations
- Easy to reset with your combination number at any time.
- Keyless convenience.
- Weather proof cover with multiple color options for managing easily

Color V

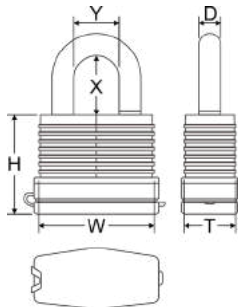

^RL40W

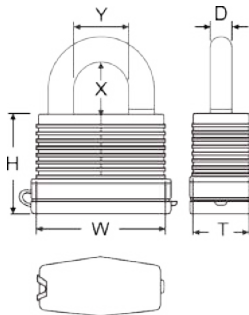

^RL46W



^Anti-dust cover

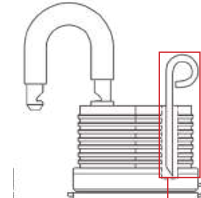

Reset from the shackle hole

Item #	DIMENSION(MM)						
	Lock Body			Shackle			Dial
	W	H	T	D	X	Y	
RL40W	45	40	32	9	21	18	3
RL46W	52	40	35	10	21	22	4

* Above items are available with six colors. Please add "color code" after the above Item#. Such as: RL40W-BK or RL46W-Y.

COMBINATION Laminated



ERL40/ERL46



Description V

A resettable laminated combination brass padlock combined with number dials device for lock opening to provide confidential, economical and practical purposes.

Features V

- Laminated steel lock body with quality plating
- Hardened steel shackle
- 3 dials with 1,000 possible combinations
- 4 dials with 10,000 possible combinations
- Easy to reset the combination number
- Keyless convenience.
- E type cover with multiple colors for managing easily

Color V

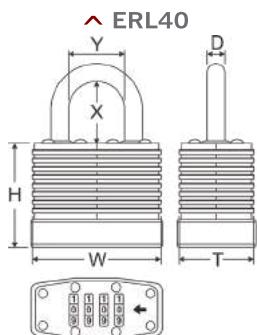
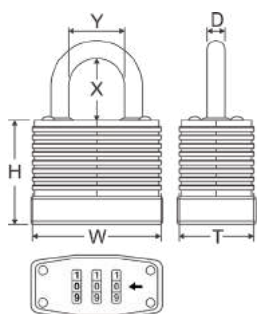

^ ERL46



^ERL40

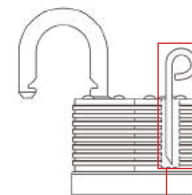

Reset from the shackle hole

Item #	DIMENSION(MM)						
	Lock Body			Shackle			Dial
	W	H	T	D	X	Y	
ERL40/25	46	35	27	6.3	25	21	3
ERL40/50	46	35	27	6.3	50	21	3
ERL46/25	51	35	30	7.9	25	24	4
ERL46/50	51	35	30	7.9	50	24	4

* Above items are available with six colors. Please add "color code" after the above Item#. Such as: ERL40/25-BK or ERL46/50-GY

RB Series

Description V

A resettable combination brass padlock combined with a protruded number dials device for lock opening to provide confidential security. For global markets except North America

Features V

- Brass lock body
- Steel shackle with quality plating
- 3 dials with 1,000 possible combinations
- 4 dials with 10,000 possible combinations
- Easy to reset with your combination number at any time without any reset tool.
- Keyless convenience.

Color V

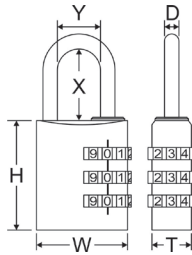

^ 3 Dials

Item #	DIMENSION(MM)						
	Lock Body			Shackle			Dial
	W	H	T	D	X	Y	
RB20	21	28	12	3.2	20	9	3
RB20/50	21	28	12	3.2	50	9	3
RB20-4	21	34	12	3.2	21	9	4
RB30	30	36	13	4.8	24	14	3
RB30/50	30	36	13	4.8	50	14	3
RB30-4	30	44	13	4.8	24	14	4
RB40	40	46	16	6	25	22	4
RB40/50	40	46	16	6	25	22	4
RB51	50	46	17	7.9	28	28	4
RB60	60	46	19	9.5	32	35	4

* Above items are available with many colors. Please add "color code" after the above Item#. Such as: RB20-Gold, or RB40-US26

COMBINATION Luggage Padlock



RB_NA Series

Description V

A resettable combination brass padlock combined with a indented number dials device for lock opening to provide confidential security. For North America market exclusively

Features V

- Brass lock body
- Steel shackle with quality plating
- 3 dials with 1,000 possible combinations
- 4 dials with 10,000 possible combinations
- Easy to reset with your combination number at any time without any reset tool.
- Keyless convenience.
- Number wheels indented.

Color V



Olive drab US26D Original Gold Platinum PVD/BK

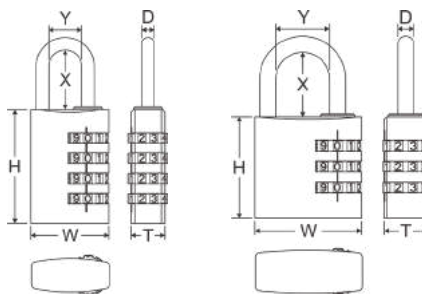

^ 4 Dials

^ 3 Dials



Item #	DIMENSION(MM)						
	Lock Body			Shackle			Dial
	W	H	T	D	X	Y	
RB30NA	30	36	13	4.8	23	13	3
RB30-4NA	30	44	13	4.8	23	13	4
RB40-3NA	40	38	16	6	25	20	3
RB40NA	40	46	16	6	24	20	4
RB51NA	50	46	17	7.93	29	27	4
RB60NA	60	46	19	9.5	32.7	34	4

* Above items are available with many colors. Please add "color code" after the above Item#. Such as: RB30-4NA-Gold, or RB40-3NA-US26

RB_OR Series



Description V

A resettable combination brass padlock is combined with a protruded number dials device and an override key system. It is designed for global marketplaces. Without using correct codes, the padlock can still be opened with an override key which is available to KD (as a spare key), KA or MK system for group management.

Features V

- Brass lock body
- Steel shackle with quality plating
- 4 dials with 10,000 possible combinations
- Easy to reset with your combination number at any time.
- The unique shackle block design provides extra shackle protection as well as alternative unlock method by an override key.
- One override key per lock

Color V



Olive drab US26D Original Gold Platinum PVD/BK

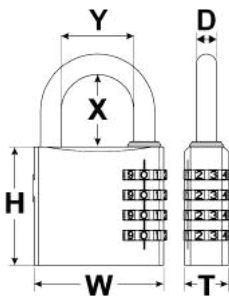

Item #	DIMENSION(MM)						
	Lock Body			Shackle			Dial
	W	H	T	D	X	Y	
RB40-OR	40	46	16	6	25	20	4
RB51-OR	50	46	17	7.9	28	27	4
RB60-OR	60	46	19	9.5	32	34	4

* Above items are available with many colors. Please add "color code" after the above Item#. Such as: RB40-OR-Gold, or RB51-OR-US26

COMBINATION Luggage Padlock



RA Series



Description V

A resettable combination aluminum padlock combined with number dials device for lock opening to provide confidential security.

Features V

- Aluminum lock body
- Steel shackle with quality plating
- 3 dials with 1,000 possible combinations
- 4 dials with 10,000 possible combinations
- Easy to reset with your combination number at any time without any reset tool.
- Keyless convenience.

Color V

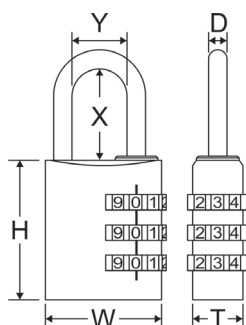
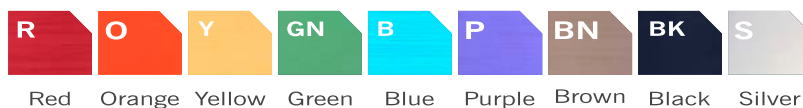

Item #	DIMENSION(MM)						
	Lock Body			Shackle			Dial
	W	H	T	D	X	Y	
RA20	21	28	12	3.2	21	9	3
RA30	30	36	13	4.8	24	14	3
RA40	40	46	16	6	26	22	4

* Above items are available with six colors. Please add "color code" after the above Item#. Such as: RA20-BK or RA40-Y.

COMBINATION Luggage Padlock

K7400



Description V

A search alerts - luggage & Case security lock usage on luggage hold by TSA accepted

Features V

- Zinc alloy lock body
- 3 dials with 1,000 possible combinations
- TSA007

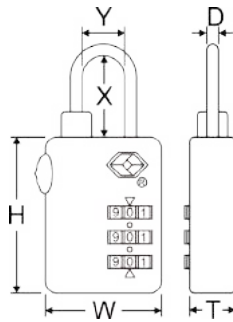

Item #	DIMENSION(MM)						
	Lock Body			Shackle			Dial
	W	H	T	D	X	Y	
K7400	31	41	11	3.2	22	11	3



CYLINDER
DOOR &
WINDOW LOCK
CABINET &
DRAWER LOCK
PADLOCK
OTHER
PINNING &
TOOLBOX
KEYBLANK



COMBINATION Luggage Padlock



341

Description V

A lock usage on luggage hold.

Features V

- Zinc alloy lock body
- 3 dials with 1,000 possible combinations



Item #	DIMENSION(MM)						
	Lock Body			Shackle			Dial
	W	H	T	D	X	Y	
341	31	38	13	4.7	20	14	3



COMBINATION Luggage Padlock



363



Description V

A lock usage on luggage hold.

Features V

- Zinc alloy lock body
- 3 dials with 1,000 possible combinations



Item #	DIMENSION(MM)						
	Lock Body			Shackle			Dial
	W	H	T	D	X	Y	
363	21	38	11	3.2	19	9	3



COMBINATION Luggage Padlock



383



Description V

A lock usage on luggage hold.

Features V

- Zinc alloy lock body
- 3 dials with 1,000 possible combinations



Item #	DIMENSION(MM)						
	Lock Body			Shackle			Dial
	W	H	T	D	X	Y	
383	22	33	11	3	20	9	3

SFIC SERIES





SFIC

The Small Format Interchangeable Core(SFIC) makes it easier and faster while switching lock without dismantling the entire door handle or lockset, hence, the Interchangeable cores are frequently applied to large commercial, institutional and residential setting. In addition, we also provide the "control key" which allows you to remove the lock housing in an easier way.

SFIC Range Small Format Interchangeable Core

SFIC

Description **V**

The Small Format Interchangeable Core(SFIC) makes it easier and faster while switching lock without dismantling the entire door handle or lockset, hence, the Interchangeable cores are frequently applied to large commercial, institutional and residential setting. In addition, we also provide the "control key" which allows you to remove the lock housing in an easier way.



Features **V**

- Solid brass construction
- High quality plating with US26D
- KA, MK GMK available
- Different Keyway can choose

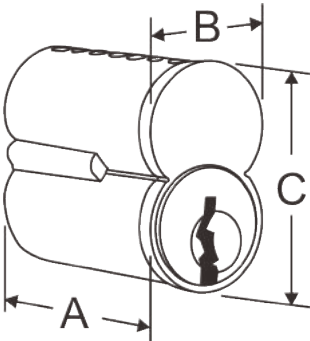

Item	Pin Qty	A	B	C
SFIC-6	6	27.2	14.1	24.3
SFIC-7	7	30.8	14.1	24.3

SFIC Keyway Drawing

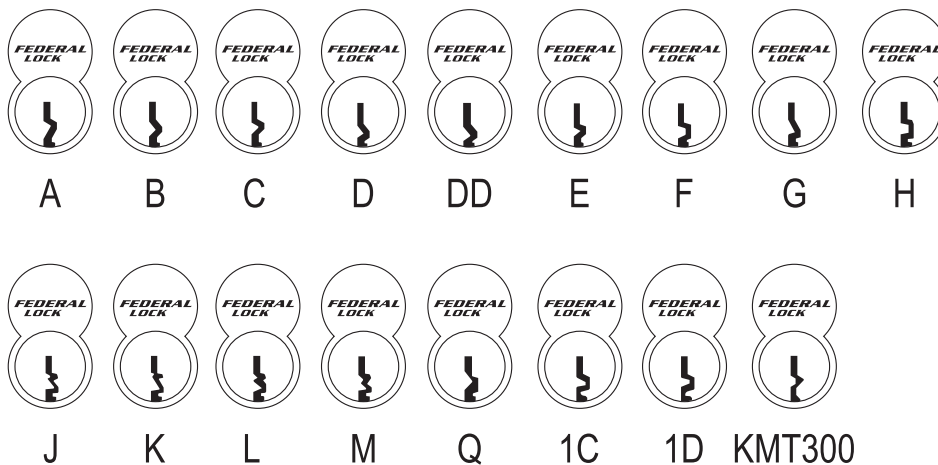

CYLINDER
DOOR & WINDOW LOCK
CABINET & DRAWER LOCK
PADLOCK
OTHER
PINNING & TOOLBOX
KEYBLANK

SFIC Range Shackleless Padlock

SX400-SFIC



Description ▼

SX400-SFIC Series Shackleless Padlock features a US26D plated/black e-coated solid steel body for drilling, sawing and impact resistances. The keyway is covered by JR cover and anti-drill disc to provide dustproof, water-resistant and anti-drill abilities. The shackleless design can effectively protect against any bolt cutter attack by concealing the shackle inside the padlock.

This lock adopts key retaining design, when the padlock is opened, the key will be retained in the lock body until the padlock is closed again. It prevents the user from walking away with the key and leaving the padlock unlocked.

This lock accepts rekeyable and changeable 6 or 7 pin SFIC cylinders. Both Stepped and Flat types are available and can be used in accordance with different types of hasps.

Application ▼

This lock is ideal for security gates, trucks, storage sheds, etc.

Features ▼

- US26D plated/Black e-coated solid steel body
- Shackleless padlock design
- Key retained
- Rekeyable and changeable 6 or 7 pin SFIC cylinders
- Anti-drill disc
- Anti-dust (JR) cover [Patented]
- Available in Stepped and Flat types
- No core, no key

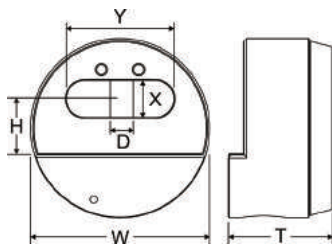

▲SX400 (Step back)

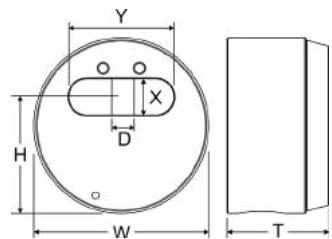

▲SX401 (Flat back)



▲Anti-dust cover



Item #	DIMENSION(MM)							Back Type	Keyway
	Lock Body			Shackle					
	W	H	T	D	X	Y			
SX400-SFIC	73	22.7	44	9.5	15	43.7	Step	No core	
SX401-SFIC	73	48.3	44	9.5	15	43.7	Flat	No Key	

* We also provide the full set of padlock. The Item # will be different according to the core it applied (6 pin or 7 pin) Such as: SX400-SFIC-6 or SX400-SFIC-7

SFIC Range Weather Proof Solid Steel JR

AU710ICW/JR



Description ▼

710ICW/JR Series features a solid hardened steel body with molybdenum shackle to resist drilling, sawing, twisting and brute force attacks. With the weather proof cover and JR cover, this lock can withstand adverse weather conditions

The patented clever shackle interchange design allows to change the shackle conveniently by using simple tools. A set screw will be attached with each lock for changing the padlock to key retaining. The double locking ball bearings increase tensile strength to resist pulling attack.

This lock accepts rekeyable and changeable 6 or 7 pin SFIC cylinders.

Application ▼

This lock is ideal for outdoor applications, such as security gates, trucks, warehouses, etc.

Features ▼

- Hardened Steel body with Weather Proof Cover
- Anti-cut molybdenum shackle
- Double ball bearing locking mechanism
- Accepts rekeyable and changeable 6 or 7 pin SFIC cylinders
- Each lock includes a set screw for changing to key retaining
- Clever shackle change design [Patented]
- Anti-dust (JR) Cover [Patented]
- No core, no key

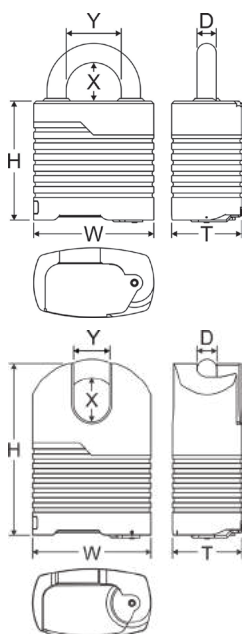

Item #	DIMENSION(MM)						Keyway
	Lock Body			Shackle			
	W	H	T	D	X	Y	
AU710ICW/JR	56	65	36	7.93	25	20	No core No key
AU720ICW/JR	63	65	39	9.5	25	20	
AU730ICW/JR	69	66	40	11.1	25	32	
Shrouded Shackle							
AU730PICW/JR	69	100	40	11.1	25	21	

* We also provide the full set of padlock. The Item # will be different according to the core it applied (6 pin or 7 pin) Such as: AU710ICW/JR-SFIC-6 or AU730PICW/JR-SFIC-7

CYLINDER
DOOR & WINDOW LOCK
CABINET & DRAWER LOCK
PADLOCK
OTHER
PINNING & TOOLBOX
KEYBLANK

SFIC Range Solid Steel

610



Description ▼

610 Series features a US26 plated solid steel lock body with molybdenum shackle to resist drilling, sawing, twisting and brute force attacks. With the blue bumper, the lock body can prevent damage to locked item.

The patented clever shackle interchange design allows to change the shackle conveniently by using simple tools. A set screw will be attached with each lock for changing the padlock to key retaining. The double locking ball bearings increase tensile strength to resist pulling attack.

This lock accepts rekeyable and changeable 6 or 7 pin SFIC cylinders.

Application ▼

This lock is ideal for garages, fences, store rooms, etc.

Features ▼

- Solid brass body with blue bumper
- Anti-cut molybdenum shackle
- Double ball bearing locking mechanism
- Accepts rekeyable and changeable 6 or 7 pin SFIC cylinders
- Each lock includes a set screw for changing to key retaining
- Clever shackle change design [Patented]
- No core, no key

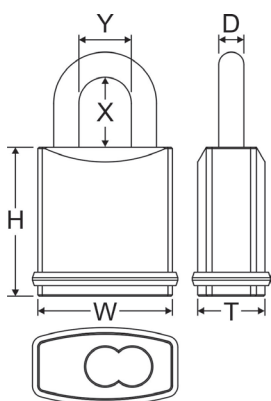

Item #	DIMENSION(MM)						Keyway
	Lock Body			Shackle			
	W	H	T	D	X	Y	
610	45	56	22	6.35	19	20	No core No key
620	45	56	22	7.93	19	20	
630	50	56	22	9.50	19	20	

* Each Item# includes several shackle dimension (X): 19, 25, 38, 50, 76, 102 (mm)
Such as: 610/25, 620/50, 630/102

* We also provide the full set of padlock. The Item # will be different according to the core it applied (6 pin or 7 pin) Such as: 610-SFIC-6 or 620-SFIC-7

SFIC Range Solid Brass

650



Description V

650 Series features a solid brass lock body with molybdenum shackle to resist corrosion and bolt cutter attack. With the blue bumper, the lock body can prevent damage to locked item.

The patented clever shackle interchange design allows to change the shackle conveniently by using simple tools. A set screw will be attached with each lock for changing the padlock to key retaining. The double locking ball bearings increase tensile strength to resist pulling attack.

This lock accepts rekeyable and changeable 6 or 7 pin SFIC cylinders.

Application V

This lock is ideal for coastal facilities, such as beach lockers, shops, sheds, etc.

Features V

- Solid brass body with blue bumper
- Anti-cut molybdenum shackle
- Double ball bearing locking mechanism
- Accepts rekeyable and changeable 6 or 7 pin SFIC cylinders
- Each lock includes a set screw for changing to key retaining
- Clever shackle change design [Patented]
- No core, no key

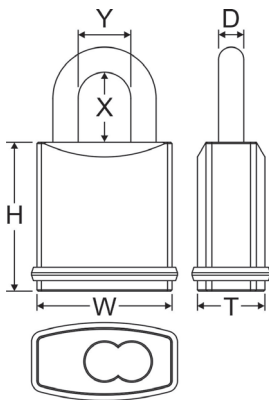

Item #	DIMENSION(MM)						Keyway
	Lock Body			Shackle			
	W	H	T	D	X	Y	
650	40	56	20	6.35	19	20	No core No key
660	45	56	22	7.93	19	20	
670	50	56	22	9.50	19	20	

* Each Item# includes several shackle dimension (X): 19, 25, 38, 50, 76, 102 (mm)
Such as: 650/25, 660/50, 670/102

* We also provide the full set of padlock. The Item # will be different according to the core it applied (6 pin or 7 pin) Such as: 660-SFIC-6 or 670-SFIC-7

SFIC Range Solid Brass

650B



Description ▼

650B Series features a solid brass lock body with brass shackle for perfect sparkproof ability and corrosion resistance. With the gray bumper, the lock body can prevent damage to locked item. The patented clever shackle interchange design allows to change the shackle conveniently by using simple tools. A set screw will be attached with each lock for changing the padlock to key retaining. The double locking ball bearings increase tensile strength to resist pulling attack.

This lock accepts rekeyable and changeable 6 or 7 pin SFIC cylinders.

Application ▼

This lock is ideal for marine and combustible substances, such as vessels, oil stations, etc.

Features ▼

- Solid brass body with gray bumper
- Brass shackle
- Double ball bearing locking mechanism
- Accepts rekeyable and changeable 6 or 7 pin SFIC cylinders
- Each lock includes a set screw for changing to key retaining
- Clever shackle change design [Patented]
- No core, no key

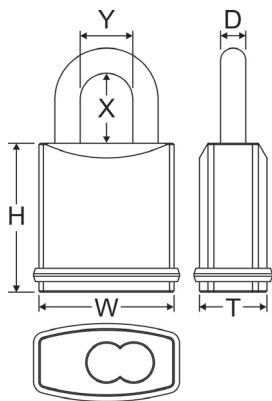

Item #	DIMENSION(MM)						Keyway
	Lock Body			Shackle			
	W	H	T	D	X	Y	
650B	40	56	20	6.35	19	20	No core No key
660B	45	56	22	7.93	19	20	
670B	50	56	22	9.50	19	20	

* Each Item# includes several shackle dimension (X): 19, 25, 38, 50, 76, 102 (mm)
Such as: 650B/25, 660B/50, 670B/102

* We also provide the full set of padlock. The Item # will be different according to the core it applied (6 pin or 7 pin) Such as: 650B-SFIC-6 or 670B-SFIC-7

SFIC Range Solid Brass

650C



Description ▼

650C Series features a US26D plated solid brass lock body with molybdenum shackle to resist corrosion and bolt cutter attack. With the blue bumper, the lock body can prevent damage to locked item.

The patented clever shackle interchange design allows to change the shackle conveniently by using simple tools. A set screw will be attached with each lock for changing the padlock to key retaining. The double locking ball bearings increase tensile strength to resist pulling attack.

This lock accepts rekeyable and changeable 6 or 7 pin SFIC cylinders.

Application ▼

This lock is ideal for coastal facilities, such as beach lockers, shops, sheds, etc.

Features ▼

- US26D plated solid brass body with blue bumper
- Anti-cut molybdenum shackle
- Double ball bearing locking mechanism
- Accepts rekeyable and changeable 6 or 7 pin SFIC cylinders
- Each lock includes a set screw for changing to key retaining
- Clever shackle change design [Patented]
- No core, no key

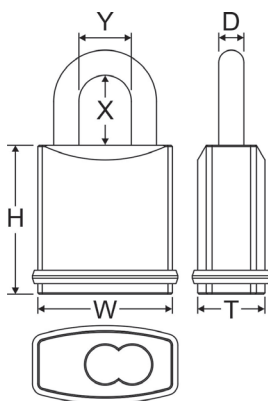

Item #	DIMENSION(MM)						Keyway
	Lock Body			Shackle			
	W	H	T	D	X	Y	
650C	40	56	20	6.35	19	20	No core No key
660C	45	56	22	7.93	19	20	
670C	50	56	22	9.50	19	20	

* Each Item# includes several shackle dimension (X): 19, 25, 38, 50, 76, 102 (mm)
Such as: 650C/25, 660C/50, 670C/102

* We also provide the full set of padlock. The Item # will be different according to the core it applied (6 pin or 7 pin) Such as: 660C-SFIC-6 or 670C-SFIC-7

SFIC Range Solid Brass

650CS



Description ▼

650CS Series features a US26D plated solid brass lock body with stainless steel shackle to resist corrosion and adverse weather conditions. With the black bumper, the lock body can prevent damage to locked item.

The patented clever shackle interchange design allows to change the shackle conveniently by using simple tools. A set screw will be attached with each lock for changing the padlock to key retaining. The double locking ball bearings increase tensile strength to resist pulling attack.

This lock accepts rekeyable and changeable 6 or 7 pin SFIC cylinders.

Application ▼

This lock is ideal for marine and combustible substances, such as vessels, oil stations, etc.

Features ▼

- US26D plated solid brass body with black bumper
- Stainless steel shackle
- Double ball bearing locking mechanism
- Accepts rekeyable and changeable 6 or 7 pin SFIC cylinders
- Each lock includes a set screw for changing to key retaining
- Clever shackle change design [Patented]
- No core, no key

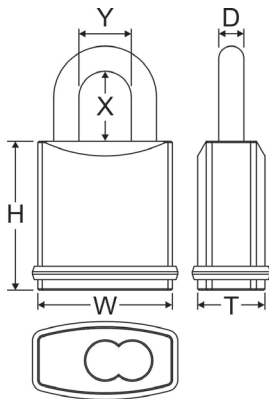

Item #	DIMENSION(MM)						Keyway
	Lock Body			Shackle			
	W	H	T	D	X	Y	
650CS	40	56	20	6.35	19	20	No core No key
660CS	45	56	22	7.93	19	20	
670CS	50	56	22	9.50	19	20	

* Each Item# includes several shackle dimension (X): 19, 25, 38, 50, 76, 102 (mm)
Such as: 650CS/25, 660CS/50, 670CS/102

* We also provide the full set of padlock. The Item # will be different according to the core it applied (6 pin or 7 pin) Such as: 650CS-SFIC-6 or 670CS-SFIC-7

SFIC Range Stainless Steel

Z840IC



Description ▼

Z840IC Series features a stainless steel lock body with stainless steel shackle to resist corrosion and adverse weather conditions. With the blue bumper, the lock body can prevent damage to locked item.

The patented clever shackle interchange design allows to change the shackle conveniently by using simple tools. A set screw will be attached with each lock for changing the padlock to key retaining. The double locking ball bearings increase tensile strength to resist pulling attack.

This lock accepts rekeyable and changeable 6 or 7 pin SFIC cylinders.

Application ▼

This lock is ideal for marine and coastal facilities, such as vessels, cargo containers, beach sheds, etc.

Features ▼

- Stainless steel body with blue bumper
- Stainless steel shackle
- Double ball bearing locking mechanism
- Accepts rekeyable and changeable 6 or 7 pin SFIC cylinders
- Each lock includes a set screw for changing to key retaining
- Clever shackle change design [Patented]
- No core, no key

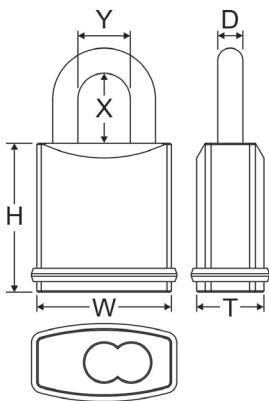

Item #	DIMENSION(MM)						Keyway
	Lock Body			Shackle			
	W	H	T	D	X	Y	
Z840IC	39	56	20	6.35	19	20	No core No key
Z845IC	44	56	23	7.93	19	20	
Z850IC	51	56	25	9.50	19	20	
Z860IC	63	56	25	11.1	19	32	

* Each Item# includes several shackle dimension (X): 19, 25, 38, 50, 76 (mm)
Such as: 840IC/25, 845IC/50, 860IC/76

* We also provide the full set of padlock. The Item # will be different according to the core it applied (6 pin or 7 pin) Such as: 840IC-SFIC-6 or 850-SFIC-7

CYLINDER
DOOR &
WINDOW LOCK
CABINET &
DRAWER LOCK
PADLOCK
OTHER
PINNING &
TOOLBOX
KEYBLANK

SFIC Range Stainless Steel JR cover

840IC/JR



Description ▼

840IC/JR Series features a stainless steel lock body with stainless steel shackle to resist corrosion and adverse weather conditions. The keyway is covered by a JR cover to provide dustproof and waterproof abilities.

The patented clever shackle interchange design allows to change the shackle conveniently by using simple tools. A set screw will be attached with each lock for changing the padlock to key retaining. The double locking ball bearings increase tensile strength to resist pulling attack.

This lock accepts rekeyable and changeable 6 or 7 pin SFIC cylinders.

Application ▼

This lock is ideal for marine and coastal facilities, such as vessels, cargo containers, beach sheds, etc.

Features ▼

- Stainless steel body
- Stainless steel shackle
- Double ball bearing locking mechanism
- Accepts rekeyable and changeable 6 or 7 pin SFIC cylinders
- Each lock includes a set screw for changing to key retaining
- Clever shackle change design [Patented]
- Anti-Dust (JR) Cover [Patented]
- No core, no key

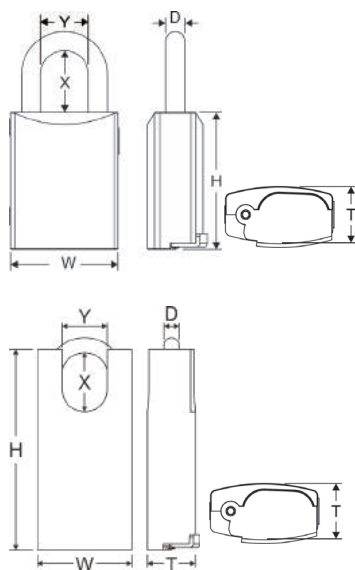

Item #	DIMENSION(MM)						Keyway	
	Lock Body			Shackle				
	W	H	T	D	X	Y		
840IC/JR	39	59	20	6.35	25	20	No core No key	
845IC/JR	44	59	23	7.93	25	20		
850IC/JR	51	59	25	9.5	25	20		
860IC/JR	63	63	25	11.1	25	32		
Shrouded Shackle								
840PIC/JR	39	85	20	6.35	25	19		
845PIC/JR	44	90	23	7.93	25	19		
850PIC/JR	51	91	25	9.5	25	20		
860PIC/JR	63	96	25	11.1	25	21		

* We also provide the full set of padlock. The Item # will be different according to the core it applied (6 pin or 7 pin) Such as: 840IC/JR-SFIC-6 or 850PIC/JR-SFIC-7

SFIC Range Solid Steel Round Padlock

900IC



Description **V**

900IC Series features a US26 plated solid steel lock body with molybdenum shackle to resist drilling, sawing, twisting and brute force attacks.

The patented clever shackle interchange design allows to change the shackle conveniently by using simple tools. A set screw will be attached with each lock for changing the padlock to key retaining. The double locking ball bearings increase tensile strength to resist pulling attack.

This lock accepts rekeyable and changeable 6 or 7 pin SFIC cylinders.

Application **V**

This lock is ideal for security gates, trucks, warehouses, etc.

Features **V**

- US26 plated solid steel lock body
- Anti-cut molybdenum shackle
- Double ball bearing locking mechanism
- Accepts rekeyable and changeable 6 or 7 pin SFIC cylinders
- Each lock includes a set screw for changing to key retaining
- Clever shackle change design [Patented]
- No core, no key

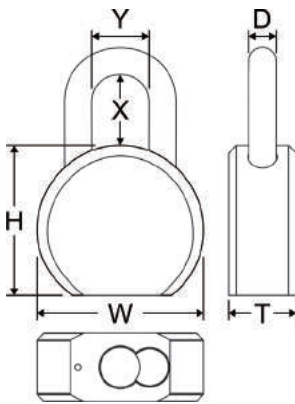

Item #	DIMENSION(MM)						Keyway
	Lock Body			Shackle			
	W	H	T	D	X	Y	
900IC	63.5	59	27	11	25	24	No core No key
902IC	63.5	59	27	11	50	24	
903IC	63.5	59	27	11	76	24	

* We also provide the full set of padlock. The Item # will be different according to the core it applied (6 pin or 7 pin) Such as: 900IC-SFIC-6 OR 903IC-SFIC-7

CYLINDER
DOOR &
WINDOW LOCK
CABINET &
DRAWER LOCK
PADLOCK
OTHER
PINNING &
TOOLBOX
KEYBLANK

SFIC Range Solid Steel Square Padlock

90IC/90PIC



Description V

90PIC Series features a US26 plated solid steel lock body with molybdenum shackle to resist drilling, sawing, twisting and brute force attacks. Steel shroud protects shackle from bolt cutters.

The patented clever shackle interchange design allows to change the shackle conveniently by using simple tools. A set screw will be attached with each lock for changing the padlock to key retaining. The double locking ball bearings increase tensile strength to resist pulling attack.

This lock accepts rekeyable and changeable 6 or 7 pin SFIC cylinders.

Application V

This lock is ideal for security gates, lockers, warehouses, etc.

Features V

- US26 plated solid steel lock body
- Anti-cut molybdenum shackle
- Double ball bearing locking mechanism
- Accepts rekeyable and changeable 6 or 7 pin SFIC cylinders
- Each lock includes a set screw for changing to key retaining
- Clever shackle change design [Patented]
- No core, no key
- Steel shroud protects shackle from bolt cutters

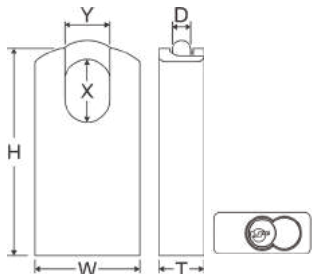
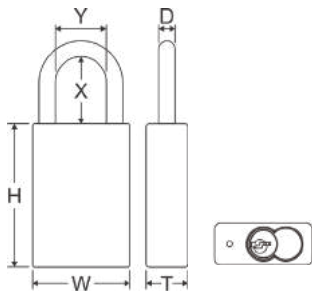

Item #	DIMENSION(MM)						Keyway
	Lock Body			Shackle			
	W	H	T	D	X	Y	
90IC	38	58	19	6.3	25	20	No core No key
100IC	45	55	19	8.0	25	20	
200IC	50	55	19	9.5	25	20	
300IC	63.5	60	25	11.0	25	32	
Shrouded Shackle							
90PIC	38	83	19	6.3	25	20	
100PIC	45	86	19	8.0	25	20	
200PIC	50	95	19	9.5	25	20	
300PIC	63.5	100	25	11.0	25	32	

* Each Item# includes several shackle dimension (X): 25, 50, 76 (mm)
Such as: 90IC/25, 200IC/50, 300IC/76

* We also provide the full set of padlock. The Item # will be different according to the core it applied (6 pin or 7 pin) Such as: 90PIC-SFIC-6 or 300PIC-SFIC-7

SFIC Range Solid Brass Square Padlock

95IC/95PIC



Description V

95PIC Series features a solid brass lock body with molybdenum shackle to resist corrosion and bolt cutter attack. Brass shroud protects shackle from bolt cutters.

The patented clever shackle interchange design allows to change the shackle conveniently by using simple tools. A set screw will be attached with each lock for changing the padlock to key retaining. The double locking ball bearings increase tensile strength to resist pulling attack.

This lock accepts rekeyable and changeable 6 or 7 pin SFIC cylinders.

Application V

This lock is ideal for coastal facilities, such as beach lockers, shops, sheds, etc.

Features V

- Solid brass lock body
- Anti-cut molybdenum shackle
- Double ball bearing locking mechanism
- Accepts rekeyable and changeable 6 or 7 pin SFIC cylinders
- Each lock includes a set screw for changing to key retaining
- Clever shackle change design [Patented]
- No core, no key
- Brass shroud protects shackle from bolt cutters

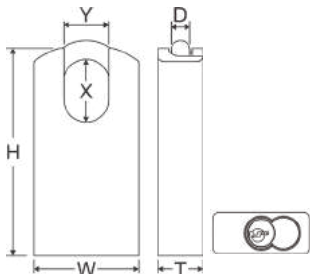
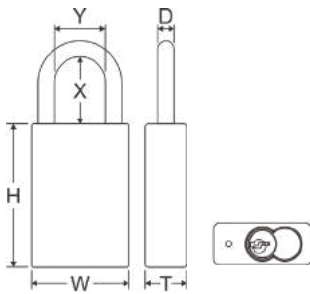

Item #	DIMENSION(MM)						Keyway
	Lock Body			Shackle			
	W	H	T	D	X	Y	
95IC	38	55	19	6.3	25	20	No core No key
150IC	45	55	19	8.0	25	20	
250IC	50	55	19	9.5	25	20	
350IC	63.5	60	25	11.0	25	32	
Shrouded Shackle							
95PIC	38	83	19	6.3	25	20	
150PIC	45	86	19	8.0	25	20	
250PIC	50	95	19	9.5	25	20	
350PIC	63.5	100	25	11.0	25	32	

* Each Item# includes several shackle dimension (X): 25, 50, 76 (mm)
Such as: 95IC/25, 250IC/50, 350IC/76

* We also provide the full set of padlock. The Item # will be different according to the core it applied (6 pin or 7 pin) Such as: 150PIC-SFIC-6 or 350PIC-SFIC-7

SFIC Range Solid Aluminum Padlock

90AIC



Description

90AIC Series features a lightweight solid aluminum lock body for great portability and multiple color options can make the group management more easier. The shackle is made of hardened steel, offering outstanding resistance to cutting, sawing and twisting.

The patented clever shackle interchange design allows to change the shackle conveniently by using simple tools. A set screw will be attached with each lock for changing the padlock to key retaining. The double locking ball bearings increase tensile strength to resist pulling attack.

This lock accepts rekeyable and changeable 6 or 7 pin SFIC cylinders.

Application

This lock is ideal for bikes, tool boxes, manufacturing environments, etc.

Features

- Solid anodized aluminum lock body
- Hardened steel shackle
- Double ball bearing locking mechanism
- Accepts rekeyable and changeable 6 or 7 pin SFIC cylinders
- Each lock includes a set screw for changing to key retaining
- Clever shackle change design [Patented]
- Multiple color options
- No core, no key

Color

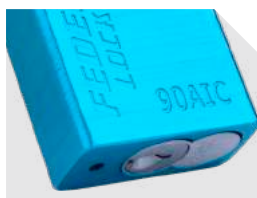
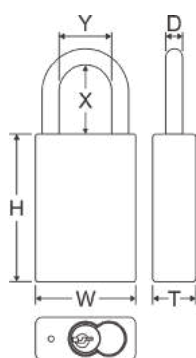
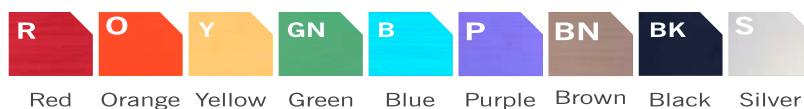

Item #	DIMENSION(MM)						Keyway
	Lock Body			Shackle			
	W	H	T	D	X	Y	
90AIC	38	55	19	6.3	25	20	No core No key
100AIC	45	55	19	8.0	25	20	
200AIC	50	55	19	9.5	25	20	

* Each Item# includes several shackle dimension (X): 25, 50, 76 (mm)
Such as: 90AIC/25, 100AIC/50, 200AIC/76

* Above items are available with six colors. Please add "color code" after the above Item#.
Such as: 90AIC-BK or 100AIC-Y.

SFIC Range Solid Aluminum JR Cover

90AIC/JR



Description ▼

90AIC Series features a lightweight solid aluminum lock body for great portability and multiple color options can make the group management more easier. The shackle is made of hardened steel, offering outstanding resistance to cutting, sawing and twisting.

The patented clever shackle interchange design allows to change the shackle conveniently by using simple tools. A set screw will be attached with each lock for changing the padlock to key retaining. The double locking ball bearings increase tensile strength to resist pulling attack.

This lock accepts rekeyable and changeable 6 or 7 pin SFIC cylinders.

Application ▼

This lock is ideal for bikes, tool boxes, manufacturing environments, etc.

Features ▼

- Solid anodized aluminum lock body
- Hardened steel shackle
- Double ball bearing locking mechanism
- Accepts rekeyable and changeable 6 or 7 pin SFIC cylinders
- Each lock includes a set screw for changing to key retaining
- Clever shackle change design [Patented]
- Multiple color options
- No core, no key

Color ▼

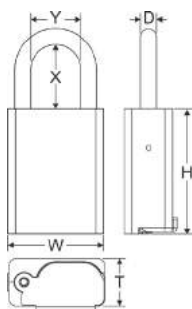
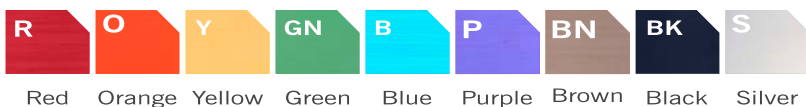

Item #	DIMENSION(MM)						Keyway
	Lock Body			Shackle			
	W	H	T	D	X	Y	
90AIC/JR	38	55	19	6.3	25	20	No core No key
100AIC/JR	45	55	19	8.0	25	20	
200AIC/JR	50	55	19	9.5	25	20	

* Each Item# includes several shackle dimension (X): 25, 50, 76 (mm)
Such as: 90AIC/JR/25, 100AIC/JR/50, 200AIC/JR/76

* Above items are available with six colors. Please add "color code" after the above Item#.
Such as: 90AIC-BK or 100AIC-Y.

LFIC PADLOCK





LFI

The Large Format Interchangeable Core (LFI)



LFIC Range Shackleless Padlock

SX400-LFIC



Description ▼

SX400-LFIC Series Shackleless Padlock features a US26D plated/black e-coated solid steel body for drilling, sawing and impact resistances. The keyway is covered by JR cover and anti-drill disc to provide dustproof, water-resistant and anti-drill abilities. The shackleless design can effectively protect against any bolt cutter attack by concealing the shackle inside the padlock.

This lock adopts key retaining design, when the padlock is opened, the key will be retained in the lock body until the padlock is closed again. It prevents the user from walking away with the key and leaving the padlock unlocked.

This lock accepts ASSA, MEDECO and SCHLAGE LFIC cylinders, different key retaining drivers and anti-drill discs will be provided corresponding to the cylinder's brand. Both Stepped and Flat types are available and can be used in accordance with different types of hasps.

Application ▼

This lock is ideal for security gates, trucks, storage sheds, etc.

Features ▼

- US26D plated/Black e-coated solid steel body
- Shackleless padlock design
- Key retained
- Accepts ASSA, MEDECO and SCHLAGE LFIC cylinders
- Anti-drill disc
- Anti-dust (JR) Cover [Patented]
- Available in Stepped and Flat types
- No core, no key

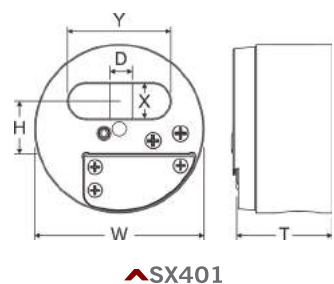
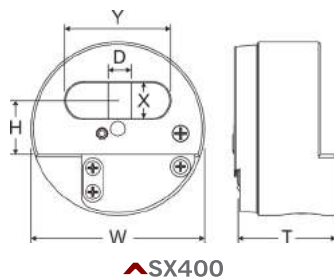

▲JR cover





Item #	DIMENSION(MM)							Back Type	Keyway
	Lock Body			Shackle					
	W	H	T	D	X	Y			
SX400-LFIC	73	22.7	50.2	9.5	15	43.7	Step	No core	
SX401-LFIC	73	48.3	50.2	9.5	15	43.7	Flat	No Key	

* We also provide the full set of padlock. The Item # will be different according to the core it applied (6 pin or 7 pin) Such as: SX400-SFIC-6 or SX400-SFIC-7



ASSA-LFIC

Cylinder Type	Key Retained Driver	Anti-drill Disc
 <p>ASSA-LFIC</p>	 <p>KR-D-C</p>	 <p>AD-A-4</p>

MEDECO-LFIC

Cylinder Type	Key Retained Driver	Anti-drill Disc
 <p>MEDECO-LFIC</p>	 <p>KR-D-C</p>	 <p>AD-A-2</p>

SCHLAGE-LFIC

Cylinder Type	Key Retained Driver	Anti-drill Disc
 <p>SCHLAGE-LFIC</p>	 <p>KR-D-C</p>	 <p>AD-A-3</p>

*Suitable to several brands as listed above

LFIC Range Solid Steel

LF610



Description ▼

LF610 Series features a US26 plated solid steel lock body with molybdenum shackle to resist drilling, sawing, twisting and brute force attacks. With the blue bumper, the lock body can prevent damage to locked item.

The patented clever shackle interchange design allows to change the shackle conveniently by using simple tools. A set screw will be attached with each lock for changing the padlock to key retaining. The double locking ball bearings increase tensile strength to resist pulling attack.

This lock accepts SCHLAGE, SARGENT, CORBIN LFIC cylinders.

Application ▼

This lock is ideal for garages, fences, store rooms, etc.

Features ▼

- US26 plated solid steel body with blue bumper
- Anti-cut molybdenum shackle
- Double ball bearing locking mechanism
- Accepts SCHLAGE, SARGENT, CORBIN LFIC cylinders
- Each lock includes a set screw for changing to key retaining
- Clever shackle change design [Patented]
- No core, no key

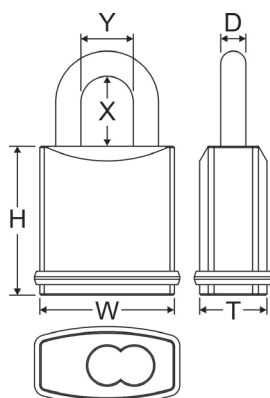

Item #	DIMENSION(MM)						Keyway
	Lock Body			Shackle			
	W	H	T	D	X	Y	
LF610	45	56	22	6.35	25	20	No core No key
LF620	45	56	22	7.93	25	20	
LF630	50	56	22	9.50	25	20	

* Each Item# includes several shackle dimension (X): 19, 25, 38, 50, 76, 102 (mm)
Such as: LF610/19, LF620/50, LF630/102

LFIC Range Brass

LF650



Description ▼

LF650 Series features a solid brass lock body with molybdenum shackle to resist corrosion and bolt cutter attack. With the blue bumper, the lock body can prevent damage to locked item.

The patented clever shackle interchange design allows to change the shackle conveniently by using simple tools. A set screw will be attached with each lock for changing the padlock to key retaining. The double locking ball bearings increase tensile strength to resist pulling attack.

This lock accepts SCHLAGE, SARGENT, CORBIN LFIC cylinders.

Application ▼

This lock is ideal for coastal facilities, such as beach lockers, shops, sheds, etc.

Features ▼

- Solid brass body with blue bumper
- Anti-cut molybdenum shackle
- Double ball bearing locking mechanism
- Accepts SCHLAGE, SARGENT, CORBIN LFIC cylinders
- Each lock includes a set screw for changing to key retaining
- Clever shackle change design [Patented]
- No core, no key

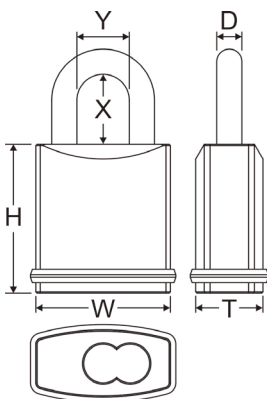

Item #	DIMENSION(MM)						Keyway
	Lock Body			Shackle			
	W	H	T	D	X	Y	
LF650	45	56	22	6.35	25	20	No core No key
LF660	45	56	22	7.93	25	20	
LF670	50	56	22	9.50	25	20	

* Each Item# includes several shackle dimension (X): 19, 25, 38, 50, 76, 102 (mm)
Such as: LF650/19, LF660/50, LF670/102

CYLINDER
DOOR &
WINDOW LOCK
CABINET &
DRAWER LOCK
PADLOCK
OTHER
PINNING &
TOOLBOX
KEYBLANK

LFIC Range Brass

LF650B



Description ▼

LF650B Series features a solid brass lock body with brass shackle for perfect sparkproof ability and corrosion resistance. With the gray bumper, the lock body can prevent damage to locked item.

The patented clever shackle interchange design allows to change the shackle conveniently by using simple tools. A set screw will be attached with each lock for changing the padlock to key retaining. The double locking ball bearings increase tensile strength to resist pulling attack.

This lock accepts SCHLAGE, SARGENT, CORBIN LFIC cylinders.

Application ▼

This lock is ideal for marine and combustible substances, such as vessels, oil stations, etc.

Features ▼

- Solid brass body with gray bumper
- Brass shackle
- Double ball bearing locking mechanism
- Accepts SCHLAGE, SARGENT, CORBIN LFIC cylinders
- Each lock includes a set screw for changing to key retaining
- Clever shackle change design [Patented]
- No core, no key

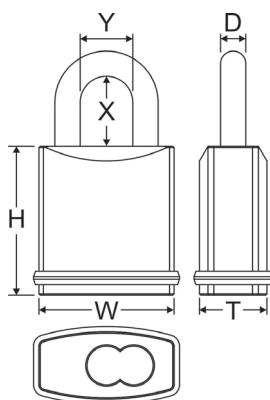

Item #	DIMENSION(MM)						Keyway
	Lock Body			Shackle			
	W	H	T	D	X	Y	
LF650B	45	56	22	6.35	25	20	No core No key
LF660B	45	56	22	7.93	25	20	
LF670B	50	56	22	9.50	25	20	

* Each Item# includes several shackle dimension (X): 19, 25, 38, 50, 76, 102 (mm)
Such as: LF650B/19, LF660/50, LF670/102

LFIC Range Brass

LF650S



Description ▼

LF650S Series features a solid brass lock body with stainless steel shackle to resist corrosion and adverse weather conditions. With the black bumper, the lock body can prevent damage to locked item.

The patented clever shackle interchange design allows to change the shackle conveniently by using simple tools. A set screw will be attached with each lock for changing the padlock to key retaining. The double locking ball bearings increase tensile strength to resist pulling attack.

This lock accepts SCHLAGE, SARGENT, CORBIN LFIC cylinders.

Application ▼

This lock is ideal for marine and coastal facilities, such as vessels, cargo containers, beach sheds, etc.

Features ▼

- Solid brass body with black bumper
- Stainless steel shackle
- Double ball bearing locking mechanism
- Accepts SCHLAGE, SARGENT, CORBIN LFIC cylinders
- Each lock includes a set screw for changing to key retaining
- Clever shackle change design [Patented]
- No core, no key

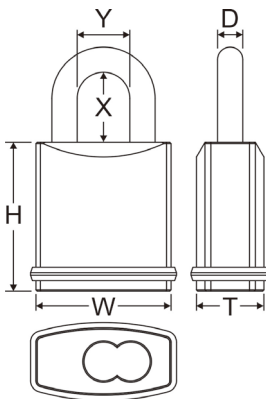

Item #	DIMENSION(MM)						Keyway
	Lock Body			Shackle			
	W	H	T	D	X	Y	
LF650S	45	56	22	6.35	25	20	No core No key
LF660S	45	56	22	7.93	25	20	
LF670S	50	56	22	9.50	25	20	

* Each Item# includes several shackle dimension (X): 19, 25, 38, 50, 76, 102 (mm)
Such as: LF650S/19, LF660S/50, LF670S/102

LFIC Range Brass

LF650C



Description ▼

LF650C Series features a US26D plated solid brass lock body with molybdenum shackle to resist corrosion and bolt cutter attack. With the blue bumper, the lock body can prevent damage to locked item.

The patented clever shackle interchange design allows to change the shackle conveniently by using simple tools. A set screw will be attached with each lock for changing the padlock to key retaining. The double locking ball bearings increase tensile strength to resist pulling attack.

This lock accepts SCHLAGE, SARGENT, CORBIN LFIC cylinders.

Application ▼

This lock is ideal for coastal facilities, such as beach lockers, shops, sheds, etc.

Features ▼

- US26D plated solid brass body with blue bumper
- Anti-cut molybdenum shackle
- Double ball bearing locking mechanism
- Accepts SCHLAGE, SARGENT, CORBIN LFIC cylinders
- Each lock includes a set screw for changing to key retaining
- Clever shackle change design [Patented]
- No core, no key

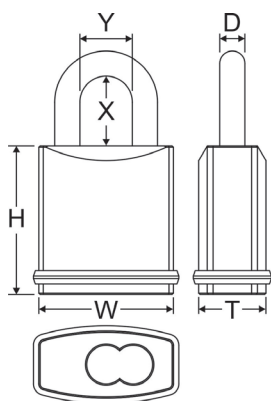

Item #	DIMENSION(MM)						Keyway
	Lock Body			Shackle			
	W	H	T	D	X	Y	
LF650C	45	56	22	6.35	25	20	No core No key
LF660C	45	56	22	7.93	25	20	
LF670C	50	56	22	9.50	25	20	

* Each Item# includes several shackle dimension (X): 19, 25, 38, 50, 76, 102 (mm)
Such as: LF650C/19, LF66C/50, LF67C/102

LFIC Range Brass

LF650CS



Description ▼

LF650CS Series features a US26D plated solid brass lock body with stainless steel shackle to resist corrosion and adverse weather conditions. With the black bumper, the lock body can prevent damage to locked item.

The patented clever shackle interchange design allows to change the shackle conveniently by using simple tools. A set screw will be attached with each lock for changing the padlock to key retaining. The double locking ball bearings increase tensile strength to resist pulling attack.

This lock accepts SCHLAGE, SARGENT, CORBIN LFIC cylinders.

Application ▼

This lock is ideal for marine and coastal facilities, such as vessels, cargo containers, beach sheds, etc.

Features ▼

- US26D plated solid brass body with black bumper
- Stainless steel shackle
- Double ball bearing locking mechanism
- Accepts SCHLAGE, SARGENT, CORBIN LFIC cylinders
- Each lock includes a set screw for changing to key retaining
- Clever shackle change design [Patented]
- No core, no key

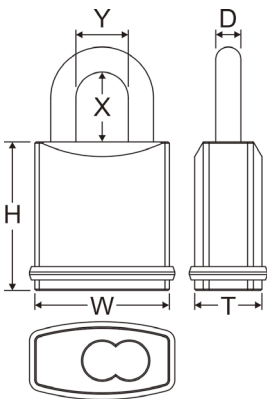

Item #	DIMENSION(MM)						Keyway
	Lock Body			Shackle			
	W	H	T	D	X	Y	
LF650CS	45	56	22	6.35	25	20	No core No key
LF660CS	45	56	22	7.93	25	20	
LF670CS	50	56	22	9.50	25	20	

* Each Item# includes several shackle dimension (X): 19, 25, 38, 50, 76, 102 (mm)
Such as: LF650CS/19, LF660CS/50, LF670CS/102

CYLINDER
DOOR & WINDOW LOCK
CABINET & DRAWER LOCK
PADLOCK
OTHER
PINNING & TOOLBOX
KEYBLANK

LFIC Range Stainless Steel

LF845



Description ▼

LF845 Series features a stainless steel lock body with stainless steel shackle to resist corrosion and adverse weather conditions. With the black bumper, the lock body can prevent damage to locked item.

The patented clever shackle interchange design allows to change the shackle conveniently by using simple tools. A set screw will be attached with each lock for changing the padlock to key retaining. The double locking ball bearings increase tensile strength to resist pulling attack.

This lock accepts SCHLAGE, SARGENT, CORBIN LFIC cylinders.

Application ▼

This lock is ideal for coastal facilities, such as beach lockers, shops, sheds, etc.

Features ▼

- Stainless steel body with black bumper
- Stainless steel shackle
- Double ball bearing locking mechanism
- Accepts SCHLAGE, SARGENT, CORBIN LFIC cylinders
- Each lock includes a set screw for changing to key retaining
- Clever shackle change design [Patented]
- No core, no key

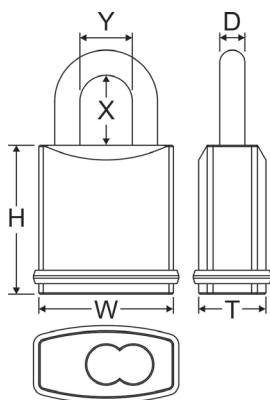

Item #	DIMENSION(MM)						Keyway
	Lock Body			Shackle			
	W	H	T	D	X	Y	
LF845/19	44	56	23	7.93	19	20	No core No key
LF845/25	44	56	23	7.93	25	20	
LF845/38	44	56	23	7.93	38	20	
LF845/50	44	56	23	7.93	50	20	
LF845/76	44	56	23	7.93	76	20	
LF845/102	44	56	23	7.93	102	20	



**KIK
PADLOCK**



KIK

This core is used in lock sets, deadbolts and padlocks. FEDERAL provide a feasible product range to adapt a wide variety of popular brands with the flexibility to cover numerous applications.

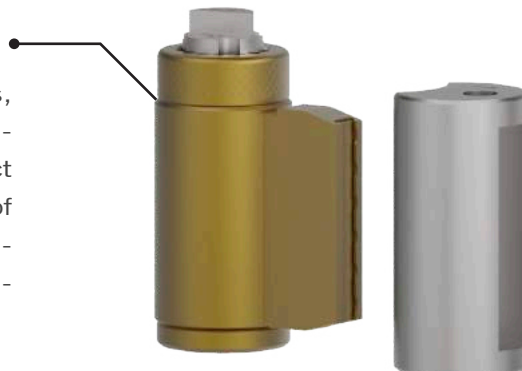

KIK Range Key in Knob Core

KIK

Description **V**

This core is used in lock sets, deadbolts and padlocks. FEDERAL provide a feasible product range to adapt a wide variety of popular brands with the flexibility to cover numerous applications.

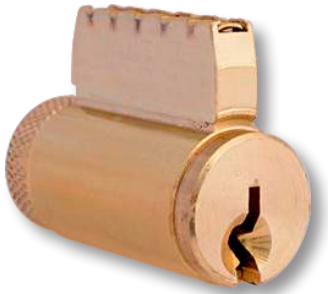

Features **V**

- Solid brass construction
- High quality plating with US26D
- KA, MK GMK available
- Different Keyway can choose

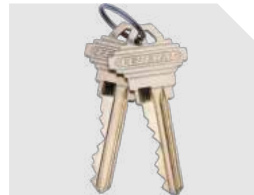
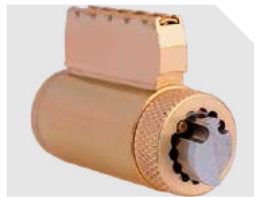
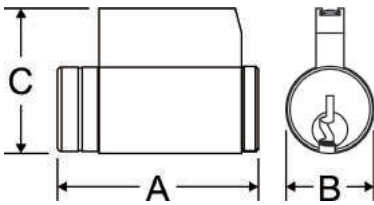

Item	Pin Qty	A	B	C
KIK-6	5	39	16	26
KIK-7	6	39	16	26

CYLINDER
 DOOR & WINDOW LOCK
 CABINET & DRAWER LOCK
 PADLOCK
 OTHER
 PINNING & TOOLBOX
 KEYBLANK

KIK Range Shackleless Padlock

SX400-KIK



Description

SX400-KIK Series Shackleless Padlock features a US26D plated/black e-coated solid steel body for drilling, sawing and impact resistances. The keyway is covered by JR cover and anti-drill disc to provide dustproof, water-resistant and anti-drill abilities. The shackleless design can effectively protect against any bolt cutter attack by concealing the shackle inside the padlock.

This lock adopts key retaining design, when the padlock is opened, the key will be retained in the lock body until the padlock is closed again. It prevents the user from walking away with the key and leaving the padlock unlocked.

This lock accepts ASSA-CLIQ, ASSA, MEDECO and SCHLAGE KIK cylinders, different key retaining drivers, anti-drill discs and cylinder retainers will be provided corresponding to the cylinder's brand. Both Stepped and Flat types are available and can be used in accordance with different types of hasps.

Application

This lock is ideal for security gates, trucks, storage sheds, etc.

Features

- US26D plated/Black e-coated solid steel body
- Shackleless padlock design
- Key retained
- Accepts ASSA-CLIQ, ASSA, MEDECO and SCHLAGE KIK cylinders
- Anti-drill disc
- Anti-dust (JR) cover [Patented]
- Available in Stepped and Flat types
- No core, no key

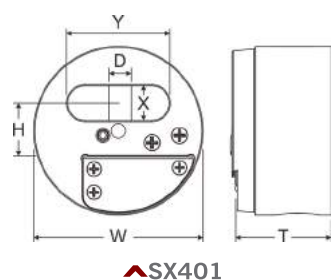
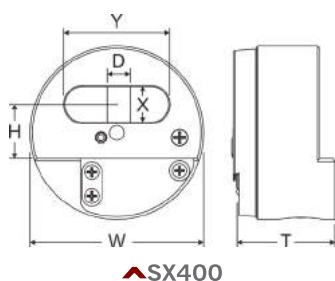

▲JR cover



▲Black E coating



Item #	DIMENSION(MM)						Back Type	Keyway
	Lock Body			Shackle				
	W	H	T	D	X	Y		
SX400-KIK	73	22.7	47	9.5	15	43.7	Step	No core
SX401-KIK	73	48.3	47	9.5	15	43.7	Flat	No Key

* Above items are suitable for 5 or 6 pin KIK core. Please add "core code" after the above Item#. Such as: SX400-KIK-5 or SX401-KIK-6

ASSA-CLIQ-KIK

Cylinder Type	Key Retained Driver	Anti-drill Disc	Cylinder Retainer
---------------	---------------------	-----------------	-------------------



ASSA-KIK

Cylinder Type	Key Retained Driver	Anti-drill Disc	Cylinder Retainer
---------------	---------------------	-----------------	-------------------

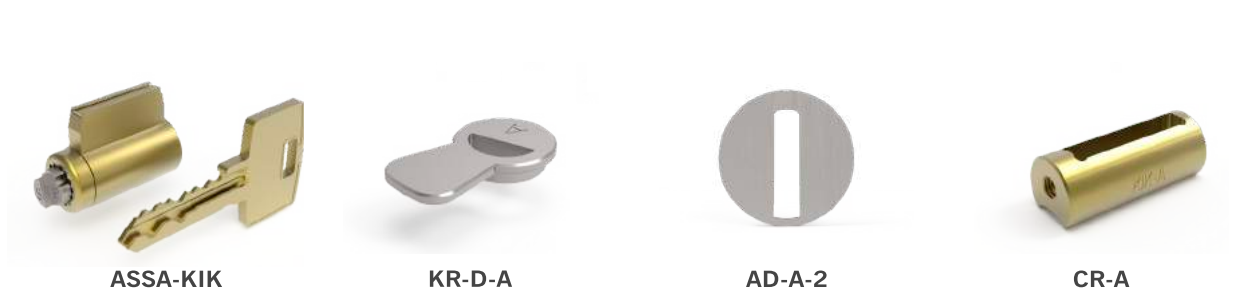

SCHLAGE-KIK

Cylinder Type	Key Retained Driver	Anti-drill Disc	Cylinder Retainer
---------------	---------------------	-----------------	-------------------

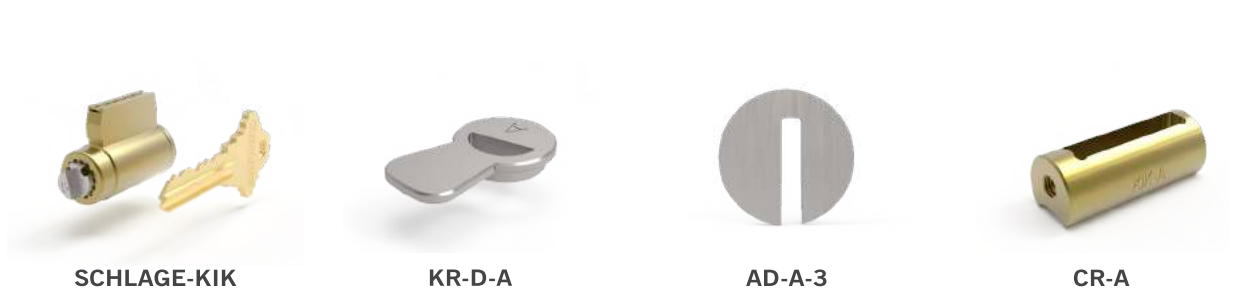

MEDECO-KIK

Cylinder Type	Key Retained Driver	Anti-drill Disc	Cylinder Retainer
---------------	---------------------	-----------------	-------------------

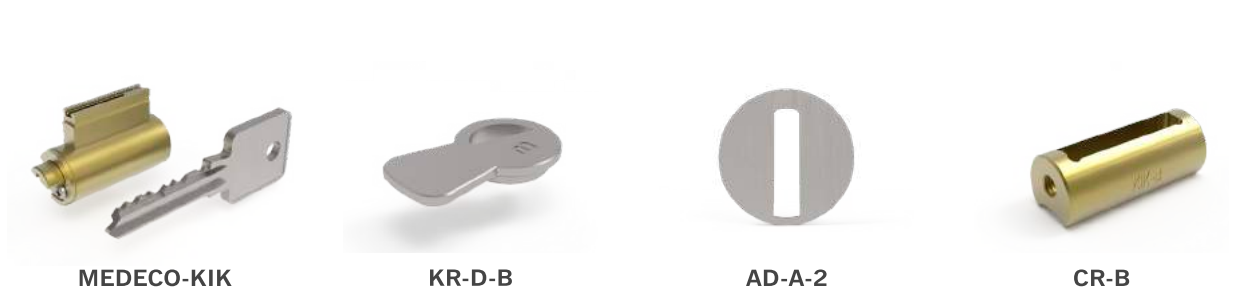

*Suitable to several brands as listed above

CYLINDER
DOOR & WINDOWLOCK
CABINET & DRAWERLOCK
PADLOCK
OTHER
PINNING & TOOLBOX
KEYBLANK

KIK Range Brass

KF450



Description ▼

KF450-6 Series features a solid brass lock body with molybdenum shackle to resist corrosion and bolt cutter attack. With the blue bumper, the lock body can prevent damage to locked item. The patented clever shackle interchange design allows to change the shackle conveniently by using simple tools. A set screw will be attached with each lock for changing the padlock to key retaining. The double locking ball bearings increase tensile strength to resist pulling attack.

Each lock comes with adapters for accepting ASSA-CLIQ, ASSA and SCHLAGE KIK cylinders.

Application ▼

This lock is ideal for coastal facilities, such as beach lockers, shops, sheds, etc.

Features ▼

- Solid brass body with blue bumper
- Anti-cut molybdenum shackle
- Double ball bearing locking mechanism
- Each lock comes with adapters for accepting ASSA-CLIQ, ASSA and SCHLAGE KIK cylinders
- Each lock includes a set screw for changing to key retaining
- Clever shackle change design [Patented]
- No core, no key

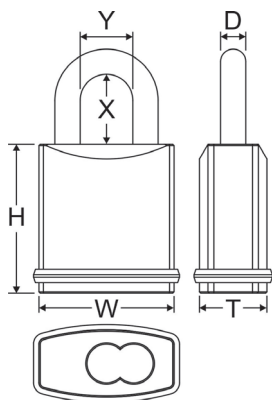

Item #	DIMENSION(MM)						Keyway
	Lock Body			Shackle			
	W	H	T	D	X	Y	
KF450-6	45	56	22	6.35	25	20	No core No key
KF450	45	56	22	7.93	25	20	
KF500	50	56	22	9.50	25	20	

* Each Item# includes several shackle dimension (X): 19, 25, 38, 50, 76, 102 (mm)
Such as: KF450-6/19, KF450/50, KF500/102

KIK Range Brass

KF450B



Description ▼

KF450B-6 Series features a solid brass lock body with brass shackle for perfect sparkproof ability and corrosion resistance. With the gray bumper, the lock body can prevent damage to locked item.

The patented clever shackle interchange design allows to change the shackle conveniently by using simple tools. A set screw will be attached with each lock for changing the padlock to key retaining. The double locking ball bearings increase tensile strength to resist pulling attack.

Each lock comes with adapters for accepting ASSA-CLIQ, ASSA and SCHLAGE KIK cylinders.

Application ▼

This lock is ideal for marine and combustible substances, such as vessels, oil stations, etc.

Features ▼

- Solid brass body with gray bumper
- Brass shackle
- Double ball bearing locking mechanism
- Each lock comes with adapters for accepting ASSA-CLIQ, ASSA and SCHLAGE KIK cylinders
- Each lock includes a set screw for changing to key retaining
- Clever shackle change design [Patented]
- No core, no key

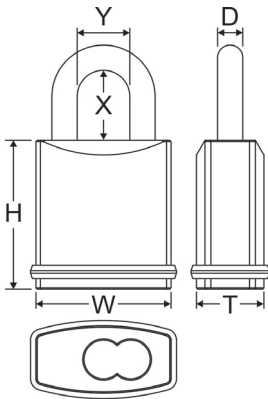

Item #	DIMENSION(MM)						Keyway
	Lock Body			Shackle			
	W	H	T	D	X	Y	
KF450B-6	45	56	22	6.35	25	20	No core No key
KF450B	45	56	22	7.93	25	20	
KF500B	50	56	22	9.50	25	20	

* Each Item# includes several shackle dimension (X): 19, 25, 38, 50, 76, 102 (mm)
Such as: KF450B-6/19, KF450B/50, KF500B/102

CYLINDER
DOOR & WINDOW LOCK
CABINET & DRAWER LOCK
PADLOCK
OTHER
PINNING & TOOLBOX
KEYBLANK

KIK Range Brass

KF450S



Description ▼

KF450S-6 Series features a solid brass lock body with stainless steel shackle to resist corrosion and adverse weather conditions. With the black bumper, the lock body can prevent damage to locked item.

The patented clever shackle interchange design allows to change the shackle conveniently by using simple tools. A set screw will be attached with each lock for changing the padlock to key retaining. The double locking ball bearings increase tensile strength to resist pulling attack.

Each lock comes with adapters for accepting ASSA-CLIQ, ASSA and SCHLAGE KIK cylinders.

Application ▼

This lock is ideal for marine and coastal facilities, such as vessels, cargo containers, beach sheds, etc.

Features ▼

- Solid brass body with black bumper
- Stainless steel shackle
- Double ball bearing locking mechanism
- Each lock comes with adapters for accepting ASSA-CLIQ, ASSA and SCHLAGE KIK cylinders
- Each lock includes a set screw for changing to key retaining
- Clever shackle change design [Patented]
- No core, no key

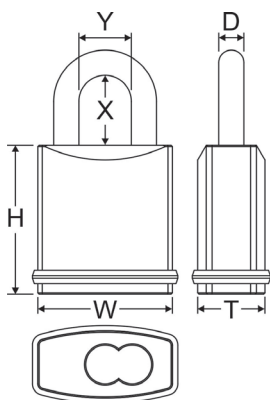

Item #	DIMENSION(MM)						Keyway
	Lock Body			Shackle			
	W	H	T	D	X	Y	
KF450S-6	45	56	22	6.35	25	20	No core No key
KF450S	45	56	22	7.93	25	20	
KF500S	50	56	22	9.50	25	20	

* Each Item# includes several shackle dimension (X): 19, 25, 38, 50, 76, 102 (mm)
Such as: KF450S-6/19, KF450S/50, KF500S/102

KIK Range Brass

KF450C



Description ▼

KF450C-6 Series features a US26D plated solid brass lock body with molybdenum shackle to resist corrosion and bolt cutter attack. With the blue bumper, the lock body can prevent damage to locked item.

The patented clever shackle interchange design allows to change the shackle conveniently by using simple tools. A set screw will be attached with each lock for changing the padlock to key retaining. The double locking ball bearings increase tensile strength to resist pulling attack.

Each lock comes with adapters for accepting ASSA-CLIQ, ASSA and SCHLAGE KIK cylinders.

Application ▼

This lock is ideal for coastal facilities, such as beach lockers, shops, sheds, etc.

Features ▼

- US26D plated solid brass body with blue bumper
- Anti-cut molybdenum shackle
- Double ball bearing locking mechanism
- Each lock comes with adapters for accepting ASSA-CLIQ, ASSA and SCHLAGE KIK cylinders
- Each lock includes a set screw for changing to key retaining
- Clever shackle change design [Patented]
- No core, no key

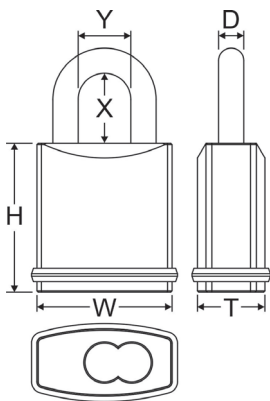

Item #	DIMENSION(MM)						Keyway
	Lock Body			Shackle			
	W	H	T	D	X	Y	
KF450C-6	45	56	22	6.35	25	20	No core No key
KF450C	45	56	22	7.93	25	20	
KF500C	50	56	22	9.50	25	20	

* Each Item# includes several shackle dimension (X): 19, 25, 38, 50, 76, 102 (mm)
Such as: KF450C-6/19, KF450C/50, KF500C/102

CYLINDER
DOOR & WINDOW LOCK
CABINET & DRAWER LOCK
PADLOCK
OTHER
PINNING & TOOLBOX
KEYBLANK

KIK Range Brass

KF450CS



Description ▼

KF450CS-6 Series features a US26D plated solid brass lock body with stainless steel shackle to resist corrosion and adverse weather conditions. With the black bumper, the lock body can prevent damage to locked item.

The patented clever shackle interchange design allows to change the shackle conveniently by using simple tools. A set screw will be attached with each lock for changing the padlock to key retaining. The double locking ball bearings increase tensile strength to resist pulling attack.

Each lock comes with adapters for accepting ASSA-CLIQ, ASSA and SCHLAGE KIK cylinders.

Application ▼

This lock is ideal for marine and coastal facilities, such as vessels, cargo containers, beach sheds, etc.

Features ▼

- US26D plated solid brass body with black bumper
- Stainless steel shackle
- Double ball bearing locking mechanism
- Each lock comes with adapters for accepting ASSA-CLIQ, ASSA and SCHLAGE KIK cylinders
- Each lock includes a set screw for changing to key retaining
- Clever shackle change design [Patented]
- No core, no key

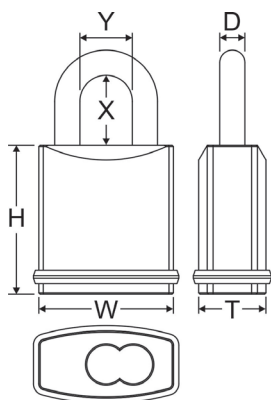

Item #	DIMENSION(MM)						Keyway
	Lock Body			Shackle			
	W	H	T	D	X	Y	
KF450CS-6	45	56	22	6.35	25	20	No core No key
KF450CS	45	56	22	7.93	25	20	
KF500CS	50	56	22	9.50	25	20	

* Each Item# includes several shackle dimension (X): 19, 25, 38, 50, 76, 102 (mm)
Such as: KF450CS-6/19, KF450CS/50, KF500CS/102

KIK Range Solid Steel

KF455



Description ▼

KF455 Series features a US26 plated solid steel lock body with molybdenum shackle to resist drilling, sawing, twisting and brute force attacks. With the blue bumper, the lock body can prevent damage to locked item.

The patented clever shackle interchange design allows to change the shackle conveniently by using simple tools. A set screw will be attached with each lock for changing the padlock to key retaining. The double locking ball bearings increase tensile strength to resist pulling attack.

Each lock comes with adapters for accepting ASSA-CLIQ, ASSA and SCHLAGE KIK cylinders.

Application ▼

This lock is ideal for garages, fences, store rooms, etc.

Features ▼

- US26 plated solid steel body with blue bumper
- Anti-cut molybdenum shackle
- Double ball bearing locking mechanism
- Each lock comes with adapters for accepting ASSA-CLIQ, ASSA and SCHLAGE KIK cylinders
- Each lock includes a set screw for changing to key retaining
- Clever shackle change design [Patented]
- No core, no key

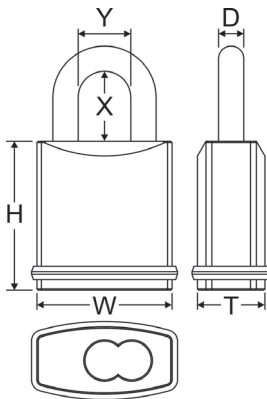

Item #	DIMENSION(MM)						Keyway
	Lock Body			Shackle			
	W	H	T	D	X	Y	
KF455	45	56	20	7.93	25	20	No core No key
KF505	45	56	22	9.50	25	20	
KF605	63	56	25	11.1	25	20	

* Each Item# includes several shackle dimension (X): 19, 25, 38, 50, 76, 102 (mm)
Such as: KF455/19, KF505/50, KF605/102

KIK Range Stainless Steel

KF845



Description ▼

KF845 Series features a stainless steel lock body with stainless steel shackle to resist corrosion and adverse weather conditions. With the black bumper, the lock body can prevent damage to locked item.

The patented clever shackle interchange design allows to change the shackle conveniently by using simple tools. A set screw will be attached with each lock for changing the padlock to key retaining. The double locking ball bearings increase tensile strength to resist pulling attack.

Each lock comes with adapters for accepting ASSA-CLIQ, ASSA and SCHLAGE KIK cylinders.

Application ▼

This lock is ideal for marine and coastal facilities, such as vessels, cargo containers, beach sheds, etc.

Features ▼

- Stainless steel body with black bumper
- Stainless steel shackle
- Double ball bearing locking mechanism
- Each lock comes with adapters for accepting ASSA-CLIQ, ASSA and SCHLAGE KIK cylinders
- Each lock includes a set screw for changing to key retaining
- Clever shackle change design [Patented]
- No core, no key

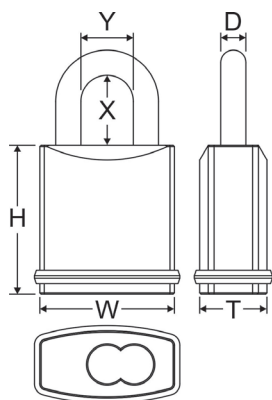

Item #	DIMENSION(MM)						Keyway
	Lock Body			Shackle			
	W	H	T	D	X	Y	
KF845	44	56	23	7.93	25	20	No core No key
KF850	51	56	25	9.50	25	20	
KF860	63	56	25	11.1	25	32	

* Each Item# includes several shackle dimension (X): 19, 25, 38, 50, 76, 102 (mm)
Such as: KF845/19, KF850/50, KF860/102

KIK Range Solid Steel

900KIK



Description ▼

900KIK Series features a US26 plated solid steel lock body with molybdenum shackle to resist drilling, sawing, twisting and brute force attacks.

The patented clever shackle interchange design allows to change the shackle conveniently by using simple tools. A set screw will be attached with each lock for changing the padlock to key retaining. The double locking ball bearings increase tensile strength to resist pulling attack.

Each lock comes with adapters for accepting ASSA-CLIQ, ASSA and SCHLAGE KIK cylinders.

Application ▼

This lock is ideal for security gates, trucks, warehouses, etc.

Features ▼

- US26 plated solid steel lock body
- Anti-cut molybdenum shackle
- Double ball bearing locking mechanism
- Each lock comes with adapters for accepting ASSA-CLIQ, ASSA and SCHLAGE KIK cylinders
- Each lock includes a set screw for changing to key retaining
- Clever shackle change design [Patented]
- No core, no key

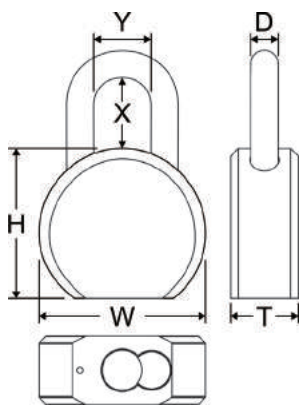

Item #	DIMENSION(MM)						Keyway
	Lock Body			Shackle			
	W	H	T	D	X	Y	
900KIK	67.5	59	27	11	25	24	No core No key
902KIK	67.5	59	27	11	50	24	
903KIK	67.5	59	27	11	76	24	

CYLINDER

DOOR &
WINDOW LOCK

CABINET &
DRAWER LOCK

PADLOCK

OTHER

PINNING &
TOOLBOX

KEYBLANK



AUNZ PADLOCK



741

**FEDERAL
LOCK**

FEDERAL
LOCK

18505
FEDERAL



AUNZ

This Specific core with C4 keyway is designed not only to fit the Australia or New Zealand markets, but also to provide those who are interested in Australia keyway option.

AUNZ

Description **V**

This Specific core with C4 keyway is designed not only to fit the Australia or New Zealand markets, but also to provide those who are interested in Australia keyway option.



Features **V**

- Solid brass construction
- KA, MK GMK available
- Anti-bump, anti-pick and anti-drill

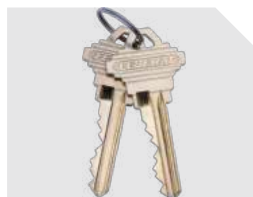
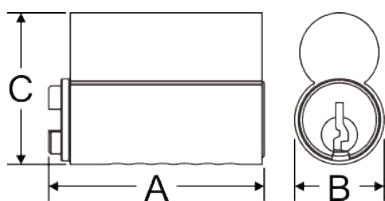

Item	Pin Qty	A	B	C
FAU6/C4	6	27.6	12.75	22.4

CYLINDER

DOOR &
WINDOW LOCK

CABINET &
DRAWER LOCK

PADLOCK

OTHER

PINNING &
TOOLBOX

KEYBLANK

AUNZ Range Shackleless Padlock



AU400



Description ▼

AU400/AU401 Series Shackleless Padlock features a e-coated or US26D plated hardened steel lock body for drilling, sawing and impact resistances. The shackleless design can effectively protect against any bolt cutter attack by concealing the shackle inside the padlock.

Both Stepped and Flat types are available and can be used in accordance with different types of hasps.

Application ▼

This lock is ideal for security gates, trucks, storage sheds, etc.

Features ▼

- E-coated or US26D plated hardened steel lock body
- Shackleless padlock design
- Rekeyable & changeable 6 pin brass anti-bump, anti-drill cylinder
- Combine with the popular types of hasp to sliding or swinging door security
- Available in Stepped and Flat types
- With two nickel silver keys

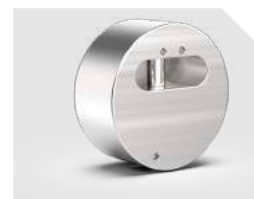
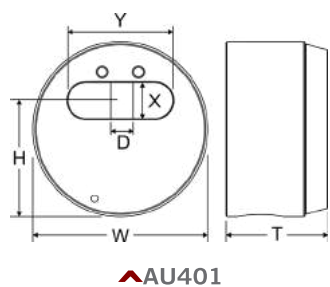
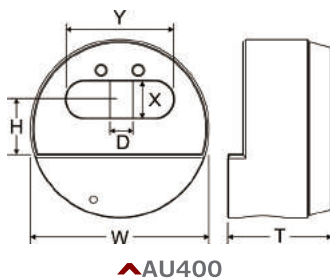

Item #	DIMENSION(MM)						Keyway	
	Lock Body			Shackle				
	W	H	T	D	X	Y		
(1) Stepped Type								
AU400	73	22.7	38	10.2	15	43.7	R37(C4)	
AU400-BK	73	22.7	38	10.2	15	43.7		
(2) Flat Type								
AU401	73	22.7	38	10.2	15	43.7		
AU401-BK	73	22.7	38	10.2	15	43.7		

AU710/AU710P



Description ▼

AU710 Series features a e-coated hardened steel lock body with molybdenum shackle to resist drilling, sawing, twisting and brute force attacks. With the blue bumper, the lock body can prevent damage to locked item. The anti-drill sliding cover plate provides high standard drilling resistance in cooperation with slide-in slot and anti-drill plate.

The patented clever shackle interchange design allows to change the shackle conveniently by using simple tools. This lock adopts a key retaining design. The design makes the key irremovable when unlocking to ensure locking operation is done before removing key and complies with the specifications of certificate and military uses. The double locking ball bearings increase tensile strength to resist pulling attack.

Application ▼

This lock is ideal for security gates, factory front, garage, entrance, etc.

Features ▼

- E-coated hardened steel lock body with blue bumper
- Anti-cut molybdenum shackle
- Rekeyable & changeable 6 pin brass anti-bump, anti-drill cylinder
- Double stainless steel ball locking
- Anti-drill sliding cover plate design
- Clever shackle change design [Patented]
- Key retaining, with two nickel silver keys

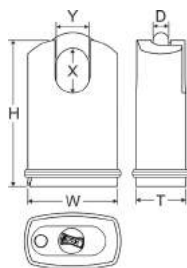
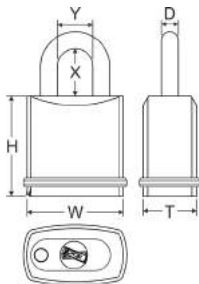

Item #	DIMENSION(MM)						Keyway	
	Lock Body			Shackle				
	W	H	T	D	X	Y		
AU710	46	59.4	28	7.93	26	20	R37(C4)	
AU720	54	59.4	30	9.5	26	20		
AU730	61	60.7	32	11.0	26	31		
AU740	70	75.6	34	14.0	26	29		
Shrouded Shackle								
AU710P	46	91.4	28	7.93	26	20		
AU720P	54	91.4	30	9.5	27	20		
AU730P	61	94.5	32	11.0	27	23		
AU740P	70	110	34	14.0	31	25		

* Each Item# includes several shackle dimension (X): 26, 50, 76 (mm)
 Such as: AU710/26, AU720/50, AU730/76, AU740/76

* You can additionally purchase key retaining connectors.

AUNZ Range Solid Steel



AU710SL/AU710PSL



Description ▼

AU710SL Series features a e-coated hardened steel lock body with molybdenum shackle to resist drilling, sawing, twisting and brute force attacks. With the blue bumper, the lock body can prevent damage to locked item. The anti-drill sliding cover plate provides high standard drilling resistance in cooperation with slide-in slot and anti-drill plate.

The patented clever shackle interchange design allows to change the shackle conveniently by using simple tools. This lock adopts a non-key retaining design. The user can pull the key out with the shackle open or closed, so key can be brought with the user without risk of losing it. The double locking ball bearings increase tensile strength to resist pulling attack.

Application ▼

This lock is ideal for security gates, factory front, garage, entrance, etc.

Features ▼

- E-coated hardened steel lock body with blue bumper
 - Anti-cut molybdenum shackle
 - Rekeyable & changeable 6 pin brass anti-bump, anti-drill cylinder
 - Double stainless steel ball locking
 - Anti-drill sliding cover plate design
 - Clever shackle change design [Patented]
 - Non-key retaining, with two nickel silver keys
- * You can additionally purchase key retaining connectors

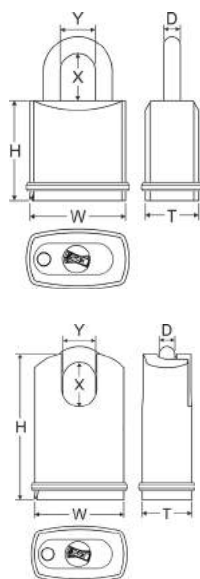

Item #	DIMENSION(MM)						Keyway
	Lock Body			Shackle			
	W	H	T	D	X	Y	
AU710SL	46	59.4	28	7.93	26	20	R37(C4)
AU720SL	54	59.4	30	9.5	26	20	
AU730SL	61	60.7	32	11.0	26	31	
AU740SL	70	75.6	34	14.0	26	29	
Shrouded Shackle							
AU710PSL	46	91.4	28	7.93	26	20	
AU720PSL	54	91.4	30	9.5	27	20	
AU730PSL	61	94.5	32	11.0	27	23	
AU740PSL	70	110	34	14.0	31	25	

* Each Item# includes several shackle dimension (X): 26, 50, 76 (mm)
Such as: AU710SL/26, AU720SL/50, AU730SL/76, AU740SL/76

* AU710SL /AU710PSL do not provide the key retaining function.

AU710BCR



Description ▼

AU710BCR Series features a satin chrome plated solid brass lock body molybdenum shackle to resist corrosion and bolt cutter attack. With the blue bumper, the lock body can prevent damage to locked item. The anti-drill sliding cover plate provides high standard drilling resistance in cooperation with slide-in slot and anti-drill plate.

The patented clever shackle interchange design allows to change the shackle conveniently by using simple tools. This lock adopts a key retaining design. The design makes the key irremovable when unlocking to ensure locking operation is done before removing key and complies with the specifications of certificate and military uses. The double locking ball bearings increase tensile strength to resist pulling attack.

Application ▼

This lock is ideal for coastal facilities, security gates, cable box, etc.

Features ▼

- Satin chrome plated solid brass lock body with blue bumper
- Anti-cut molybdenum shackle
- Rekeyable & changeable 6 pin brass anti-bump, anti-drill cylinder
- Double stainless steel ball locking
- Anti-drill sliding cover plate design
- Clever shackle change design [Patented]
- Key retaining, with two nickel silver keys

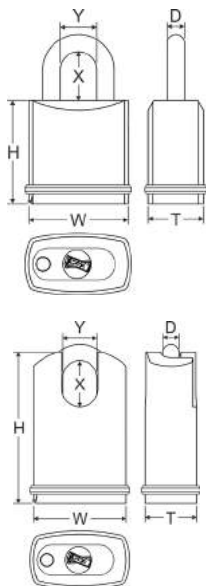

Item #	DIMENSION(MM)						Keyway
	Lock Body			Shackle			
	W	H	T	D	X	Y	
AU710BCR	46	59.4	28	7.93	26	20	R37(C4)
AU720BCR	54	59.4	30	9.5	26	20	
AU730BCR	61	60.7	32	11.0	26	31	
Shrouded Shackle							
AU710PBCR	46	91.4	28	7.93	26	20	
AU720PBCR	54	91.4	30	9.50	27	20	
AU730PBCR	61	94.5	32	11.0	27	23	

* Each Item# includes several shackle dimension (X): 26, 50, 76 (mm)
 Such as: AU710BCR/26, AU720BCR/50, AU730BCR/76

AUNZ Range Solid Brass



AU710BCRSL



Description ▼

AU710BCR Series features a satin chrome plated solid brass lock body molybdenum shackle to resist corrosion and bolt cutter attack. With the blue bumper, the lock body can prevent damage to locked item. The anti-drill sliding cover plate provides high standard drilling resistance in cooperation with slide-in slot and anti-drill plate.

The patented clever shackle interchange design allows to change the shackle conveniently by using simple tools. This lock adopts a key retaining design. The design makes the key irremovable when unlocking to ensure locking operation is done before removing key and complies with the specifications of certificate and military uses. The double locking ball bearings increase tensile strength to resist pulling attack.

Application ▼

This lock is ideal for coastal facilities, security gates, cable box, etc.

Features ▼

- Satin chrome plated solid brass lock body with blue bumper
- Anti-cut molybdenum shackle
- Rekeyable & changeable 6 pin brass anti-bump, anti-drill cylinder
- Double stainless steel ball locking
- Anti-drill sliding cover plate design
- Clever shackle change design [Patented]
- Key retaining, with two nickel silver keys

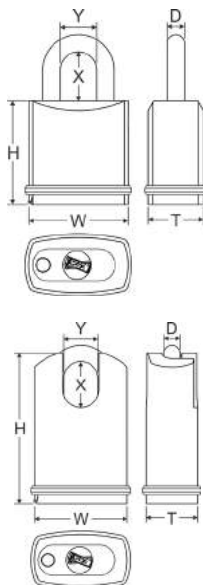

Item #	DIMENSION(MM)						Keyway
	Lock Body			Shackle			
	W	H	T	D	X	Y	
AU710BCRSL	46	59.4	28	7.93	26	20	R37(C4)
AU720BCRSL	54	59.4	30	9.5	26	20	
AU730BCRSL	61	60.7	32	11.0	26	31	
Shrouded Shackle							
AU710PBCRSL	46	91.4	28	7.93	26	20	
AU720PBCRSL	54	91.4	30	9.50	27	20	
AU730PBCRSL	61	94.5	32	11.0	27	23	

* Each Item# includes several shackle dimension (X): 26, 50, 76 (mm)
Such as: AU710BCRSL/26, AU720BCRSL/50, AU730BCRSL/76

AU650 / AU670P



Description ▼

AU650 Series features a solid brass lock body with molybdenum shackle to resist corrosion and bolt cutter attack. With the blue bumper, the lock body can prevent damage to locked item. The patented clever shackle interchange design allows to change the shackle conveniently by using simple tools. This lock adopts a non-key retaining design. The user can pull the key out with the shackle open or closed, so key can be brought with the user without risk of losing it. The double locking ball bearings increase tensile strength to resist pulling attack.

Application ▼

This lock is ideal for coastal facilities, such as beach lockers, shops, sheds, etc.

Features ▼

- Solid brass lock body with blue bumper
 - Anti-cut molybdenum shackle
 - Rekeyable & changeable 6 pin brass anti-bump, anti-drill cylinder
 - Double ball bearing locking mechanism
 - Clever shackle change design [Patented]
 - Non-key retaining, with two nickel silver keys
- * You can additionally purchase key retaining connectors.

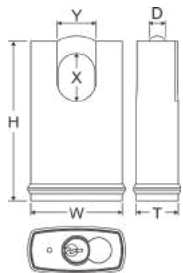
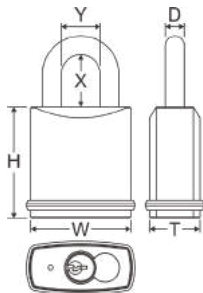

Item #	DIMENSION(MM)						Keyway
	Lock Body			Shackle			
	W	H	T	D	X	Y	
AU650	40	54	20	6.35	25	20	R37(C4)
AU660	45	54	22	7.93	26	20	
AU670	50	54	22	9.50	26	20	
Shrouded Shackle							
AU670P	50	87	22	9.50	26	20	

* Each Item# includes several shackle dimension (X): 26, 50, 76 (mm)
Such as: AU650/26, AU660/50, AU670/76

AUNZ Range Stainless Steel



AU840 / AU850P



Description ▼

AU840 Series features a stainless steel lock body with stainless steel shackle to resist corrosion and adverse weather conditions. With the blue bumper, the lock body can prevent damage to locked item.

The patented clever shackle interchange design allows to change the shackle conveniently by using simple tools. This lock adopts a non-key retaining design. The user can pull the key out with the shackle open or closed, so key can be brought with the user without risk of losing it. The double locking ball bearings increase tensile strength to resist pulling attack. The double locking ball bearings increase tensile strength to resist pulling attack.

Application ▼

This lock is ideal for marine and coastal facilities, such as vessels, cargo containers, beach sheds, etc.

Features ▼

- Stainless steel lock body with blue bumper
 - Stainless steel shackle
 - Rekeyable & changeable 6 pin brass anti-bump, anti-drill cylinder with two nickel silver keys
 - Double ball bearing locking mechanism
 - Clever shackle change design [Patented]
 - Non-key retaining, with two nickel silver keys
- * You can additionally purchase key retaining connectors.

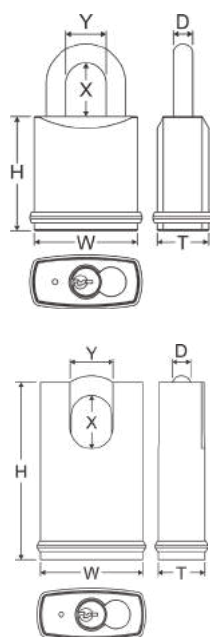

Item #	DIMENSION(MM)						Keyway	
	Lock Body			Shackle				
	W	H	T	D	X	Y		
AU840	40	54	20	6.35	25	20	R37(C4)	
AU845	44	54	23	7.93	26	20		
AU850	50	54	25	9.50	26	20		
AU860	63	58	25	11.1	26	31		
Shrouded Shackle								
AU850P	50	86	25	9.50	26	20		
AU860P	63	92	25	11.1	26	31		

* Each Item# includes several shackle dimension (X): 26, 50, 76 (mm)
Such as: AU840/26, AU850/50, AU860/76

AU731/AU731DS



Description ▼

AU731 / AU741 Series features a e-coated hardened steel lock body with molybdenum shackle to resist drilling, sawing, twisting and brute force attacks. The rectangular design limits the spacing and blocks the access to blot cutter when the lock is in place. The anti-drill sliding cover plate provides high standard drilling resistance in cooperation with slide-in slot and anti-drill plate.

Both single and double slot options are available and can be used in accordance with chains or hasps.

Application ▼

This lock is ideal for security warehouse, factory gates, lorries etc.

Features ▼

- Hardened steel lock body with e-coating
- Anti-cut molybdenum shackle
- Rekeyable & changeable 6 pin brass anti-bump, anti-drill cylinder
- Double stainless steel ball locking
- Anti-drill sliding cover plate design
- With two nickel silver keys

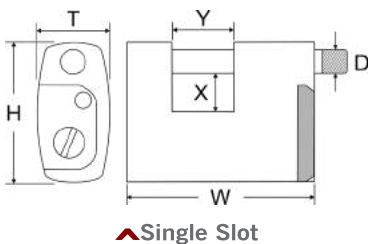

▲Single Slot

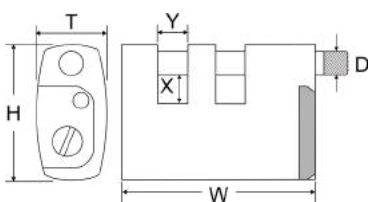

▲Double Slot



▲Double Slot



Item #	DIMENSION(MM)						Keyway	
	Lock Body			Shackle				
	W	H	T	D	X	Y		
(1) Single Slot								
AU731	89	61	32	11.1	16.1	27	R37(C4)	
AU741	120	70	34	14	26.9	48		
(2) Double Slot								
AU731DS	102	61	32	11.1	16.1	13		
AU741DS	120	70	34	14	26.9	16		

* DS refers to double slots for going with the chain. To prevent the heavy lock from dropping off, the first slot will be opened when unlocking. By twisting and pulling the shackle the second slot can be opened.

AUNZ Range Solid Steel Round Padlock



AU900R



Description ▼

AU900R Series features a e-coated hardened steel lock body with molybdenum shackle to resist drilling, sawing, twisting and brute force attacks. The anti-drill sliding cover plate provides high standard drilling resistance in cooperation with slide-in slot and anti-drill plate.

The patented clever shackle interchange design allows to change the shackle conveniently by using simple tools. This lock adopts a key retaining design. The design makes the key irremovable when unlocking to ensure locking operation is done before removing key and complies with the specifications of certificate and military uses. The double locking ball bearings increase tensile strength to resist pulling attack.

Application ▼

This lock is ideal for security gates, trucks, warehouses, etc.

Features ▼

- E-coated hardened steel lock body
 - Anti-cut molybdenum shackle
 - Rekeyable & changeable 6 pin brass anti-bump, anti-drill cylinder
 - Double stainless steel ball locking
 - Anti-drill sliding cover plate design
 - Clever shackle change design [Patented]
 - Key retaining, with two nickel silver keys
- * You can additionally purchase key retaining connectors.

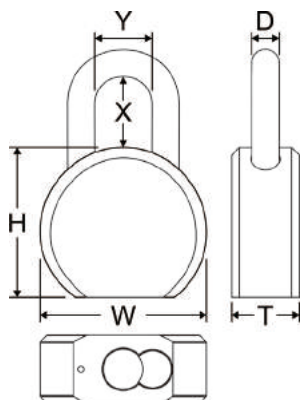

Item #	DIMENSION(MM)						Keyway
	Lock Body			Shackle			
	W	H	T	D	X	Y	
AU900R	67.5	61	28	11	27.4	23	No core No key
AU902R	67.5	61	28	11	51	23	
AU903R	67.5	61	28	11	76	23	

AU900RSL



Description ▼

AU900RSL Series features a e-coated hardened steel lock body with molybdenum shackle to resist drilling, sawing, twisting and brute force attacks. The anti-drill sliding cover plate provides high standard drilling resistance in cooperation with slide-in slot and anti-drill plate.

The patented clever shackle interchange design allows to change the shackle conveniently by using simple tools. This lock adopts a non-key retaining design. The user can pull the key out with the shackle open or closed, so key can be brought with the user without risk of losing it. The double locking ball bearings increase tensile strength to resist pulling attack.

Application ▼

This lock is ideal for security gates, trucks, warehouses, etc.

Features ▼

- E-coated hardened steel lock body
- Anti-cut molybdenum shackle
- Rekeyable & changeable 6 pin brass anti-bump, anti-drill cylinder
- Double stainless steel ball locking
- Anti-drill sliding cover plate design
- Clever shackle change design [Patented]
- Non-key retaining, with two nickel silver keys
- * You can additionally purchase key retaining connectors.

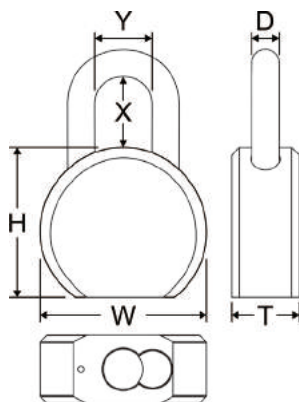

Item #	DIMENSION(MM)						Keyway
	Lock Body			Shackle			
	W	H	T	D	X	Y	
AU900RSL	67.5	61	28	11	27.4	23	No core No key
AU902RSL	67.5	61	28	11	51	23	
AU903RSL	67.5	61	28	11	76	23	

CYLINDER

DOOR &
WINDOW LOCK

CABINET &
DRAWER LOCK

PADLOCK

OTHER

PINNING &
TOOLBOX

KEYBLANK



CA6CK PADLOCK

Convenient, safe.
No matter what your purpose is.
Our combination padlock is your best companions



CA6CK

This core is used in lock sets, deadbolts and padlocks. FEDERAL provide a feasible product range to adapt a wide variety of popular brands with the flexibility to cover numerous applications.

CA6CK Range CA6CK Core

CA6CK

Description **V**

This core is used in lock sets, deadbolts and padlocks. FEDERAL provide a feasible product range to adapt a wide variety of popular brands with the flexibility to cover numerous applications.



Features **V**

- Solid brass construction
- High quality plating with US26D
- KA, MK GMK available
- Different Keyway can choose

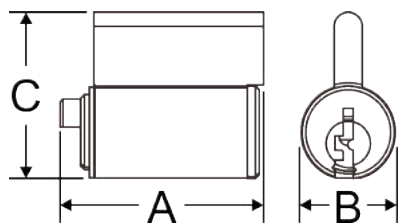

Item	Pin Qty	A	B	C
CA6CK	6	28	26.73	15.75

CA6CK Range Shackleless Padlock



S400/S401



Description V

S400/S401 Series Shackleless Padlock features a e-coated or US26D plated hardened steel lock body for drilling, sawing and impact resistances. The shackleless design can effectively protect against any bolt cutter attack by concealing the shackle inside the padlock.

Both Stepped and Flat types are available and can be used in accordance with different types of hasps.

Application V

This lock is ideal for security gates, trucks, storage sheds, etc.

Features V

- E-coated or US26D plated hardened steel lock body
- Shackleless padlock design
- Rekeyable & changeable 6 pin anti-bump, anti-drill & anti-pick cylinder with two keys
- Combine with the popular types of hasp to sliding or swinging door security
- Available in Stepped and Flat types
- KA, MK & GMK available

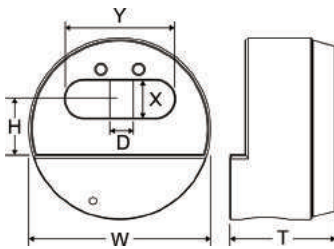

▲S400

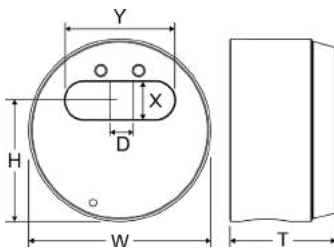

▲S401



▲Stepped Type

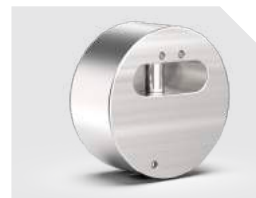

▲Flat Type



Item #	DIMENSION(MM)						Keyway	
	Lock Body			Shackle				
	W	H	T	D	X	Y		
(1) Stepped Type								
S400	73	22.7	38	10.2	15	43.7	RO	
S400-BK	73	22.7	38	10.2	15	43.7		
(2) Flat Type								
S401	73	22.7	38	10.2	15	43.7		
S401-BK	73	22.7	38	10.2	15	43.7		

* Above items are suitable for 4050 or 4060 hasp.

CYLINDER
DOOR &
WINDOW LOCK
CABINET &
DRAWER LOCK
PADLOCK
OTHER
PINNING &
TOOLBOX
KEYBLANK

CA6CK Range Solid Steel Rectangular Padlock



731 /731DS



Description ▼

731 / 731DS Series features a e-coated hardened steel lock body with molybdenum shackle to resist drilling, sawing, twisting and brute force attacks. The rectangular design limits the spacing and blocks the access to blot cutter when the lock is in place. The anti-drill sliding cover plate provides high standard drilling resistance in cooperation with slide-in slot and anti-drill plate.

Both single and double slot options are available and can be used in accordance with chains or hasps.

DS refers to double slots for going with the chain. To prevent the heavy lock from dropping off, the first slot will be opened when unlocking. By twisting and pulling the shackle the second slot can be opened.

Application ▼

This lock is ideal for security warehouse, factory gates, lorries etc.

Features ▼

- E-coated hardened steel lock body
- Anti-cut molybdenum shackle
- Rekeyable & changeable 6 pin brass anti-bump, anti-drill & anti-pick cylinder with two keys
- Stainless steel ball locking
- Anti-drill sliding cover plate design
- Available in single and double slot options
- KA, MK & GMK available

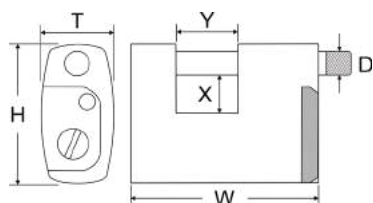

▲Single Slot

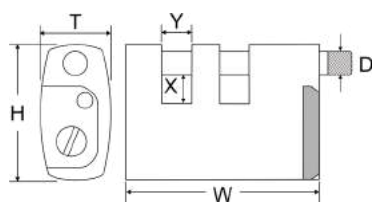

▲Double Slot



▲Double Slot



Item #	DIMENSION(MM)						Keyway	
	Lock Body			Shackle				
	W	H	T	D	X	Y		
(1) Single Slot								
731	82	61	32	11.1	16.1	27	R0	
741	103	70	34	14	26.9	48		
(2) Double Slot								
731DS	90	61	32	11.1	16.1	13		
741DS	103	70	34	14	26.9	16		

* DS refers to double slots for going with the chain. To prevent the heavy lock from dropping off, the first slot will be opened when unlocking. By twisting and pulling the shackle the second slot can be opened.

S900R



Description ▼

S900R Series features a e-coated hardened steel lock body with molybdenum shackle to resist drilling, sawing, twisting and brute force attacks. The anti-drill sliding cover plate provides high standard drilling resistance in cooperation with slide-in slot and anti-drill plate.

The patented clever shackle interchange design allows to change the shackle conveniently by using simple tools. This lock adopts a key retaining design. The design makes the key irremovable when unlocking to ensure locking operation is done before removing key and complies with the specifications of certificate and military uses. The double locking ball bearings increase tensile strength to resist pulling attack.

Application ▼

This lock is ideal for security gates, trucks, warehouses, etc.

Features ▼

- E-coated solid hardened steel lock body
- Anti-cut molybdenum shackle
- Rekeyable & changeable 6 pin brass anti-bump, anti-drill, anti-pick cylinder
- Double stainless steel ball locking
- Anti-drill sliding cover plate design
- Clever shackle change design [Patented]
- Two keys per lock
- KA, MK & GMK available
- Certification: sold secure padlock fittings Bronze

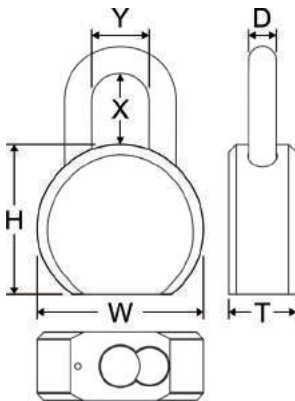

Certification >



Item #	DIMENSION(MM)						Keyway
	Lock Body			Shackle			
	W	H	T	D	X	Y	
S900R	63.5	57	27	11	27	23	R0
S902R	63.5	57	27	11	51	23	
S903R	63.5	57	27	11	76	23	

CYLINDER
 DOOR &
 WINDOW LOCK
 CABINET &
 DRAWER LOCK
 PADLOCK
 OTHER
 PINNING &
 TOOLBOX
 KEYBLANK

CA6CK Range Solid Steel Round Padlock



S900RSL



Description ▼

S900R Series features a e-coated hardened steel lock body with molybdenum shackle to resist drilling, sawing, twisting and brute force attacks. The anti-drill sliding cover plate provides high standard drilling resistance in cooperation with slide-in slot and anti-drill plate.

The patented clever shackle interchange design allows to change the shackle conveniently by using simple tools. This lock adopts a key retaining design. The design makes the key irremovable when unlocking to ensure locking operation is done before removing key and complies with the specifications of certificate and military uses. The double locking ball bearings increase tensile strength to resist pulling attack.

Application ▼

This lock is ideal for security gates, trucks, warehouses, etc.

Features ▼

- E-coated solid hardened steel lock body
- Anti-cut molybdenum shackle
- Rekeyable & changeable 6 pin brass anti-bump, anti-drill, anti-pick cylinder
- Double stainless steel ball locking
- Anti-drill sliding cover plate design
- Clever shackle change design [Patented]
- Two keys per lock
- KA, MK & GMK available
- Certification: sold secure padlock fittings Bronze

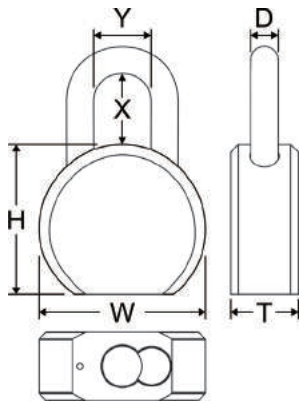

Item #	DIMENSION(MM)						Keyway
	Lock Body			Shackle			
	W	H	T	D	X	Y	
S900RSL	63.5	57	27	11	27	23	R0
S902RSL	63.5	57	27	11	51	23	
S903RSL	63.5	57	27	11	76	23	

CA6CK Range Solid Steel Round Padlock



900 Series



Description ▼

900 Series features a satin chrome plated solid steel lock body with molybdenum shackle to resist drilling, sawing, twisting and brute force attacks.

The patented clever shackle interchange design allows to change the shackle conveniently by using simple tools. The double locking ball bearings increase tensile strength to resist pulling attack.

Application ▼

This lock is ideal for security gates, trucks, warehouses, etc.

Features ▼

- Satin chrome plated solid hardened steel lock body
- Anti-cut molybdenum shackle
- Rekeyable & changeable 6 pin brass anti-bump, anti-drill, anti-pick cylinder
- Double ball locking mechanism
- Clever shackle change design [Patented]
- Two keys per lock
- KA, MK & GMK available

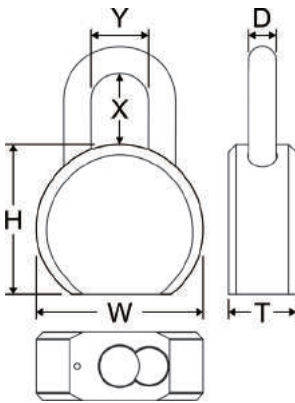

Item #	DIMENSION(MM)						Keyway
	Lock Body			Shackle			
	W	H	T	D	X	Y	
900	63.5	56	27	11	27	24	R0
902	63.5	56	27	11	51	24	
903	63.5	56	27	11	76	24	

CYLINDER

DOOR & WINDOW LOCK

CABINET & DRAWER LOCK

PADLOCK

OTHER

PINNING & TOOLBOX

KEYBLANK

CA6CK Range Solid Steel



710 /710P



Description ▼

710 Series features a e-coated hardened steel lock body with molybdenum shackle to resist drilling, sawing, twisting and brute force attacks. With the blue bumper, the lock body can prevent damage to locked item. The anti-drill sliding cover plate provides high standard drilling resistance in cooperation with slide-in slot and anti-drill plate.

The patented clever shackle interchange design allows to change the shackle conveniently by using simple tools. This lock adopts a key retaining design. The design makes the key irremovable when unlocking to ensure locking operation is done before removing key and complies with the specifications of certificate and military uses. The double locking ball bearings increase tensile strength to resist pulling attack.

Application ▼

This lock is ideal for security gates, factory front, garage, entrance, etc.

Features ▼

- E-coated hardened steel lock body with blue bumper
- Anti-cut molybdenum shackle
- Rekeyable & changeable 6 pin brass anti-bump, anti-drill, anti-pick cylinder with two keys
- Double stainless steel ball locking system
- Anti-drill sliding cover plate design
- Clever shackle change design [Patented]
- KA & MK available

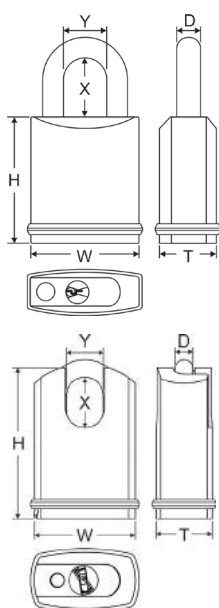

Item #	DIMENSION(MM)						
	Lock Body			Shackle			Keyway
	W	H	T	D	X	Y	
710	46	49	28	8.0	25	20	R0
Shrouded Type							
710P	46	80	28	8.0	25	20	R0

* Item# 710 includes several shackle dimension (X): 25, 50, 76 (mm)
Such as: 710/25, 710/50, 710/76

710SL /710PSL



Description ▼

710SL Series features a e-coated hardened steel lock body with molybdenum shackle to resist drilling, sawing, twisting and brute force attacks. With the blue bumper, the lock body can prevent damage to locked item. The anti-drill sliding cover plate provides high standard drilling resistance in cooperation with slide-in slot and anti-drill plate.

The patented clever shackle interchange design allows to change the shackle conveniently by using simple tools. This lock adopts a non-key retaining design. The user can pull the key out with the shackle open or closed, so key can be brought with the user without risk of losing it. The spring-loaded shackle makes the lock easier to use and let the user visually tell if the lock is unlocked or locked. The double locking ball bearings increase tensile strength to resist pulling attack.

Application ▼

This lock is ideal for security gates, factory front, garage, entrance, etc.

Features ▼

- E-coated hardened steel lock body with blue bumper
- Anti-cut molybdenum shackle
- Rekeyable & changeable 6 pin brass anti-bump, anti-drill, anti-pick cylinder with two keys
- Double stainless steel ball locking system
- Anti-drill sliding cover plate design
- Clever shackle change design [Patented]
- Non-key retaining, shackle spring loaded
- KA & MK available

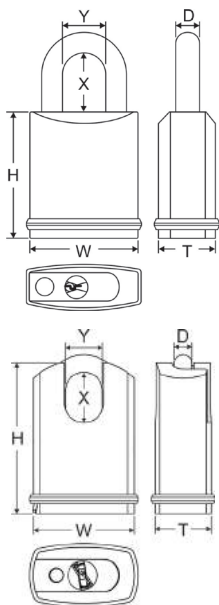

Item #	DIMENSION(MM)						Keyway
	Lock Body			Shackle			
	W	H	T	D	X	Y	
710SL	46	49	28	8.0	25	20	R0
Shrouded Type							
710PSL	46	80	28	8.0	25	20	R0

* Item# 710SL includes several shackle dimension (X): 25, 50, 76 (mm)
 Such as: 710SL/25, 710SL/50, 710SL/76

CA6CK Range Solid Steel



720 /720P



Description ▼

720 Series features a e-coated hardened steel lock body with molybdenum shackle to resist drilling, sawing, twisting and brute force attacks. With the blue bumper, the lock body can prevent damage to locked item. The anti-drill sliding cover plate provides high standard drilling resistance in cooperation with slide-in slot and anti-drill plate.

The patented clever shackle interchange design allows to change the shackle conveniently by using simple tools. This lock adopts a key retaining design. The design makes the key irremovable when unlocking to ensure locking operation is done before removing key and complies with the specifications of certificate and military uses. The double locking ball bearings increase tensile strength to resist pulling attack.

Application ▼

This lock is ideal for security gates, factory front, garage, entrance, etc.

Features ▼

- E-coated hardened steel lock body with blue bumper
- Anti-cut molybdenum shackle
- Rekeyable & changeable 6 pin brass anti-bump, anti-drill, anti-pick cylinder with two keys
- Double stainless steel ball locking system
- Anti-drill sliding cover plate design
- Clever shackle change design [Patented]
- KA & MK available

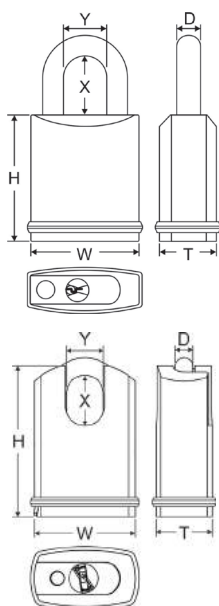

Item #	DIMENSION(MM)						
	Lock Body			Shackle			Keyway
	W	H	T	D	X	Y	
720	54	49	30	9.5	25	20	R0
Shrouded Type							
720P	54	80	30	9.5	27	20	R0

* Item# 720 includes several shackle dimension (X): 25, 50, 76 (mm)
Such as: 720/25, 720/50, 720/76

720SL /720PSL



Description ▼

720SL Series features a e-coated hardened steel lock body with molybdenum shackle to resist drilling, sawing, twisting and brute force attacks. With the blue bumper, the lock body can prevent damage to locked item. The anti-drill sliding cover plate provides high standard drilling resistance in cooperation with slide-in slot and anti-drill plate.

The patented clever shackle interchange design allows to change the shackle conveniently by using simple tools. This lock adopts a non-key retaining design. The user can pull the key out with the shackle open or closed, so key can be brought with the user without risk of losing it. The spring-loaded shackle makes the lock easier to use and let the user visually tell if the lock is unlocked or locked. The double locking ball bearings increase tensile strength to resist pulling attack.

Application ▼

This lock is ideal for security gates, factory front, garage, entrance, etc.

Features ▼

- E-coated hardened steel lock body with blue bumper
- Anti-cut molybdenum shackle
- Rekeyable & changeable 6 pin brass anti-bump, anti-drill, anti-pick cylinder with two keys
- Double stainless steel ball locking system
- Anti-drill sliding cover plate design
- Clever shackle change design [Patented]
- Non-key retaining, shackle spring loaded
- KA & MK available

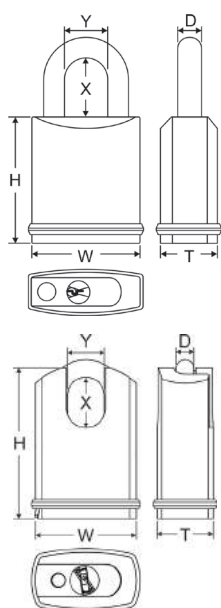

Item #	DIMENSION(MM)						
	Lock Body			Shackle			Keyway
	W	H	T	D	X	Y	
720SL	54	49	30	9.5	25	20	R0
Shrouded Type							
720PSL	54	80	30	9.5	27	20	R0

* Item# 720SL includes several shackle dimension (X): 25, 50, 76 (mm)
Such as: 720SL/25, 720SL/50, 720SL/76

CA6CK Range Solid Steel



730 /730P



Description ▼

730 Series features a e-coated hardened steel lock body with molybdenum shackle to resist drilling, sawing, twisting and brute force attacks. With the blue bumper, the lock body can prevent damage to locked item. The anti-drill sliding cover plate provides high standard drilling resistance in cooperation with slide-in slot and anti-drill plate.

The patented clever shackle interchange design allows to change the shackle conveniently by using simple tools. This lock adopts a key retaining design. The design makes the key irremovable when unlocking to ensure locking operation is done before removing key and complies with the specifications of certificate and military uses. The double locking ball bearings increase tensile strength to resist pulling attack.

Application ▼

This lock is ideal for security gates, factory front, garage, entrance, etc.

Features ▼

- E-coated hardened steel lock body with blue bumper
- Anti-cut molybdenum shackle
- Rekeyable & changeable 6 pin brass anti-bump, anti-drill, anti-pick cylinder with two keys
- Double stainless steel ball locking system
- Anti-drill sliding cover plate design
- Clever shackle change design [Patented]
- KA & MK available

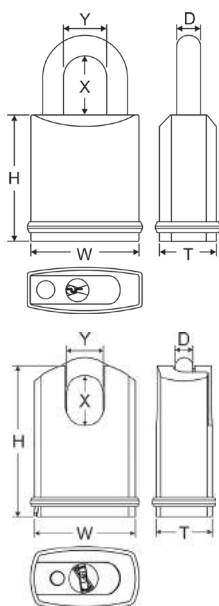

Certification >



Item #	DIMENSION(MM)						
	Lock Body			Shackle			Keyway
	W	H	T	D	X	Y	
730	61	61	32	11.0	26	31	R0
Shrouded Type							
730P	61	87	32	11.0	27	23	R0

* Item# 730 includes several shackle dimension (X): 25, 50, 76 (mm)
Such as: 730/25, 730/50, 730/76

730SL /730PSL



Description ▼

730SL Series features a e-coated hardened steel lock body with molybdenum shackle to resist drilling, sawing, twisting and brute force attacks. With the blue bumper, the lock body can prevent damage to locked item. The anti-drill sliding cover plate provides high standard drilling resistance in cooperation with slide-in slot and anti-drill plate.

The patented clever shackle interchange design allows to change the shackle conveniently by using simple tools. This lock adopts a key retaining design. The design makes the key irremovable when unlocking to ensure locking operation is done before removing key and complies with the specifications of certificate and military uses. The double locking ball bearings increase tensile strength to resist pulling attack.

Application ▼

This lock is ideal for security gates, factory front, garage, entrance, etc.

Features ▼

- E-coated hardened steel lock body with blue bumper
- Anti-cut molybdenum shackle
- Rekeyable & changeable 6 pin brass anti-bump, anti-drill, anti-pick cylinder with two keys
- Double stainless steel ball locking system
- Anti-drill sliding cover plate design
- Clever shackle change design [Patented]
- KA & MK available

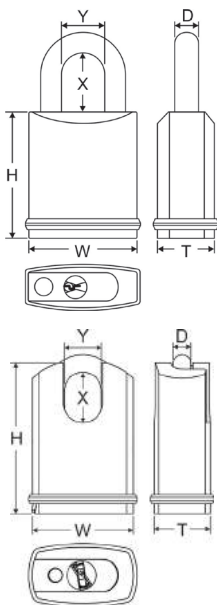

Certification >



Item #	DIMENSION(MM)						
	Lock Body			Shackle			Keyway
	W	H	T	D	X	Y	
730SL	61	61	32	11.0	26	31	R0
Shrouded Type							
730PSL	61	87	32	11.0	27	23	R0

* Item# 730SL includes several shackle dimension (X): 25, 50, 76 (mm)
Such as: 730SL/25, 730SL/50, 730SL/76

CA6CK Range Solid Steel



740 /740P



Description ▼

740 Series features a e-coated hardened steel lock body with molybdenum shackle to resist drilling, sawing, twisting and brute force attacks. With the blue bumper, the lock body can prevent damage to locked item. The anti-drill sliding cover plate provides high standard drilling resistance in cooperation with slide-in slot and anti-drill plate.

The patented clever shackle interchange design allows to change the shackle conveniently by using simple tools. This lock adopts a key retaining design. The design makes the key irremovable when unlocking to ensure locking operation is done before removing key and complies with the specifications of certificate and military uses. The double locking ball bearings increase tensile strength to resist pulling attack.

Application ▼

This lock is ideal for security gates, factory front, garage, entrance, etc.

Features ▼

- E-coated hardened steel lock body with blue bumper
- Anti-cut molybdenum shackle
- Rekeyable & changeable 6 pin brass anti-bump, anti-drill, anti-pick cylinder with two keys
- Double stainless steel ball locking system
- Anti-drill sliding cover plate design
- Clever shackle change design [Patented]
- KA & MK available

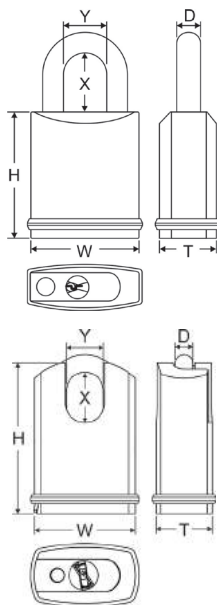

Certification >



Item #	DIMENSION(MM)						
	Lock Body			Shackle			Keyway
	W	H	T	D	X	Y	
740	70	66	34	14.0	30	29	R0
Shrouded Type							
740P	70	94	34	14.0	31	25	R0

* Item# 740 includes several shackle dimension (X): 30 , 50, 76 (mm)
Such as: 740/30, 740/50, 740/76

740SL /740PSL



Description ▼

740SL Series features a e-coated hardened steel lock body with molybdenum shackle to resist drilling, sawing, twisting and brute force attacks. With the blue bumper, the lock body can prevent damage to locked item. The anti-drill sliding cover plate provides high standard drilling resistance in cooperation with slide-in slot and anti-drill plate.

The patented clever shackle interchange design allows to change the shackle conveniently by using simple tools. This lock adopts a non-key retaining design. The user can pull the key out with the shackle open or closed, so key can be brought with the user without risk of losing it. The spring-loaded shackle makes the lock easier to use and let the user visually tell if the lock is unlocked or locked. The double locking ball bearings increase tensile strength to resist pulling attack.

Application ▼

This lock is ideal for security gates, factory front, garage, entrance, etc.

Features ▼

- E-coated hardened steel lock body with blue bumper
- Anti-cut molybdenum shackle
- Rekeyable & changeable 6 pin brass anti-bump, anti-drill, anti-pick cylinder with two keys
- Double stainless steel ball locking system
- Anti-drill sliding cover plate design
- Clever shackle change design [Patented]
- Non-key retaining, shackle spring loaded
- KA & MK available

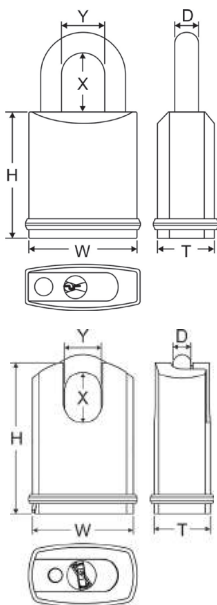

Item #	DIMENSION(MM)						
	Lock Body			Shackle			Keyway
	W	H	T	D	X	Y	
740SL	70	66	34	14.0	30	29	R0
Shrouded Type							
740PSL	70	94	34	14.0	31	25	R0

* Item# 740 includes several shackle dimension (X): 30 , 50, 76 (mm)
 Such as: 740/30, 740/50, 740/76

CA6CK Range Solid Brass



710B /710PB



Description ▼

710B Series features a solid brass lock body with molybdenum shackle to resist corrosion and bolt cutter attack. With the blue bumper, the lock body can prevent damage to locked item. The anti-drill sliding cover plate provides high standard drilling resistance in cooperation with slide-in slot and anti-drill plate. The patented clever shackle interchange design allows to change the shackle conveniently by using simple tools. This lock adopts a key retaining design. The design makes the key irremovable when unlocking to ensure locking operation is done before removing key and complies with the specifications of certificate and military uses. The double locking ball bearings increase tensile strength to resist pulling attack.

Application ▼

This lock is ideal for coastal facilities, such as beach lockers, shops, sheds, etc.

Features ▼

- Solid brass lock body with blue bumper
- Anti-cut molybdenum shackle
- Rekeyable & changeable 6 pin brass anti-bump, anti-drill, anti-pick cylinder
- Double stainless steel ball locking
- Anti-drill sliding cover plate design
- Clever shackle change design [Patented]
- Two keys per lock
- KA, MK & GMK available

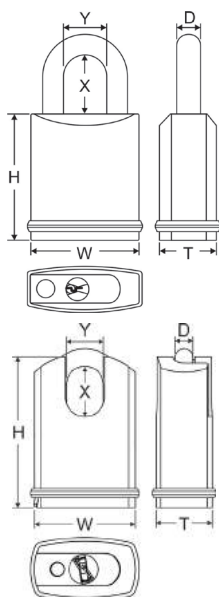

Item #	DIMENSION(MM)						Keyway
	Lock Body			Shackle			
	W	H	T	D	X	Y	
710B	46	49	28	8.0	25	20	R0
720B	54	49	30	9.5	25	20	
730B	61	61	32	11.0	26	31	
Shrouded Shackle							
710PB	46	80	28	8.0	26	20	
720PB	54	80	30	9.5	27	20	
730PB	61	87	32	11.0	27	23	

* Each Item# includes several shackle dimension (X): 25, 50, 76 (mm)
Such as: 710B/25, 720B/50, 730B/76

CA6CK Range Solid Brass



710BSL /710PBSL



Description ▼

710BSL Series features a solid brass lock body with molybdenum shackle to resist corrosion and bolt cutter attack. With the blue bumper, the lock body can prevent damage to locked item. The anti-drill sliding cover plate provides high standard drilling resistance in cooperation with slide-in slot and anti-drill plate.

The patented clever shackle interchange design allows to change the shackle conveniently by using simple tools. This lock adopts a non-key retaining design. The user can pull the key out with the shackle open or closed, so key can be brought with the user without risk of losing it. The spring-loaded shackle makes the lock easier to use and let the user visually tell if the lock is unlocked or locked. The double locking ball bearings increase tensile strength to resist pulling attack.

Application ▼

This lock is ideal for coastal facilities, such as beach lockers, shops, sheds, etc.

Features ▼

- Solid brass lock body with blue bumper
- Anti-cut molybdenum shackle
- Rekeyable & changeable 6 pin brass anti-bump, anti-drill, anti-pick cylinder
- Double stainless steel ball locking
- Anti-drill sliding cover plate design
- Clever shackle change design [Patented]
- Non-key retaining, with shackle spring design and two keys
- KA, MK & GMK available

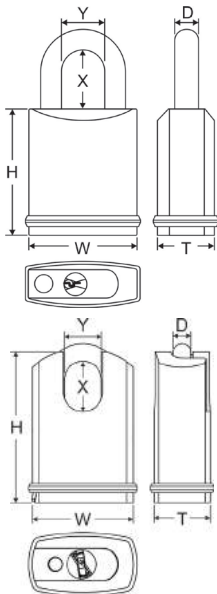

Item #	DIMENSION(MM)						Keyway
	Lock Body			Shackle			
	W	H	T	D	X	Y	
710BSL	46	49	28	8.0	25	20	R0
720BSL	54	49	30	9.5	25	20	
730BSL	61	61	32	11.0	25	31	
Shrouded Type							
710PBSL	46	80	28	8.0	25	20	
720PBSL	54	80	30	9.5	27	20	
730PBSL	61	87	32	11.0	27	23	

* Each Item# includes several shackle dimension (X): 25, 50, 76 (mm)
Such as: 710BSL/25, 720BSL/50, 730BSL/76

CYLINDER
DOOR & WINDOW LOCK
CABINET & DRAWER LOCK
PADLOCK
OTHER
PINNING & TOOLBOX
KEYBLANK

CA6CK Range Solid Brass



710BCS /710PBCS



Description ▼

710BCS Series features a satin chrome plated solid brass lock body with stainless steel shackle for superior corrosion resistance. With the blue bumper, the lock body can prevent damage to locked item. The anti-drill sliding cover plate provides high standard drilling resistance in cooperation with slide-in slot and anti-drill plate.

The patented clever shackle interchange design allows to change the shackle conveniently by using simple tools. This lock adopts a key retaining design. The design makes the key irremovable when unlocking to ensure locking operation is done before removing key and complies with the specifications of certificate and military uses. The double locking ball bearings increase tensile strength to resist pulling attack.

Application ▼

This lock is ideal for coastal facilities, such as beach lockers, shops, sheds, etc.

Features ▼

- Solid brass lock body with blue bumper
- Anti-cut molybdenum shackle
- Rekeyable & changeable 6 pin brass anti-bump, anti-drill, anti-pick cylinder
- Double stainless steel ball locking
- Anti-drill sliding cover plate design
- Clever shackle change design [Patented]
- Two keys per lock
- KA, MK & GMK available

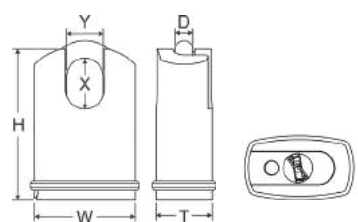
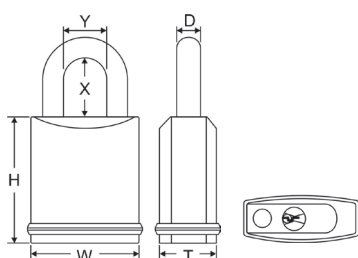

Item #	DIMENSION(MM)						Keyway
	Lock Body			Shackle			
	W	H	T	D	X	Y	
710BCS	46	49	28	8.0	25	20	R0
720BCS	54	49	30	9.5	25	20	
730BCS	61	61	32	11.0	26	31	
Shrouded Type							
710PBCS	46	80	28	8.0	25	20	
720PBCS	54	80	30	9.5	27	20	
730PBCS	61	87	32	11.0	27	23	

* Each Item# includes several shackle dimension (X): 25, 50, 76 (mm)
Such as: 710BCS/25, 720BCS/50, 730BCS/76

710BCSSL /710PBCSSL



Description ▼

710BCSSL Series features a satin chrome plated solid brass lock body with stainless steel shackle for superior corrosion resistance. With the blue bumper, the lock body can prevent damage to locked item. The anti-drill sliding cover plate provides high standard drilling resistance in cooperation with slide-in slot and anti-drill plate. The patented clever shackle interchange design allows to change the shackle conveniently by using simple tools. This lock adopts a non-key retaining design. The user can pull the key out with the shackle open or closed, so key can be brought with the user without risk of losing it. The spring-loaded shackle makes the lock easier to use and let the user visually tell if the lock is unlocked or locked. The double locking ball bearings increase tensile strength to resist pulling attack.

Application ▼

This lock is ideal for coastal facilities, such as beach lockers, shops, sheds, etc.

Features ▼

- Satin chrome plated solid brass lock body with blue bumper
- Stainless steel shackle
- Rekeyable & changeable 6 pin brass anti-bump, anti-drill, anti-pick cylinder
- Double stainless steel ball locking
- Anti-drill sliding cover plate design
- Clever shackle change design [Patented]
- Non-key retaining, with shackle spring design and two keys
- KA, MK & GMK available

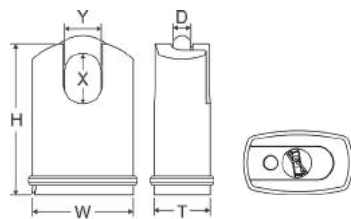
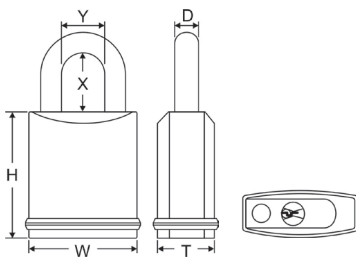

Item #	DIMENSION(MM)						Keyway
	Lock Body			Shackle			
	W	H	T	D	X	Y	
710BCSSL	46	49	28	8.0	25	20	R0
720BCSSL	54	49	30	9.5	25	20	
730BCSSL	61	61	32	11.0	26	31	
Shrouded Type							
710PBCSSL	46	80	28	8.0	25	20	
720PBCSSL	54	80	30	9.5	27	20	
730PBCSSL	61	87	32	11.0	27	23	

* Each Item# includes several shackle dimension (X): 25, 50, 76 (mm)
 Such as: 710BCSSL/25, 720BCSSL/50, 730BCSSL/76

CA6CK Range Solid Brass



710BCR/710PBCR



Description ▼

710BCR Series features a satin chrome plated solid brass lock body molybdenum shackle to resist corrosion and bolt cutter attack. With the blue bumper, the lock body can prevent damage to locked item. The anti-drill sliding cover plate provides high standard drilling resistance in cooperation with slide-in slot and anti-drill plate. The patented clever shackle interchange design allows to change the shackle conveniently by using simple tools. This lock adopts a key retaining design. The design makes the key irremovable when unlocking to ensure locking operation is done before removing key and complies with the specifications of certificate and military uses. The double locking ball bearings increase tensile strength to resist pulling attack.

Application ▼

This lock is ideal for coastal facilities, such as beach lockers, shops, sheds, etc.

Features ▼

- Solid brass lock body with blue bumper
- Anti-cut molybdenum shackle
- Rekeyable & changeable 6 pin brass anti-bump, anti-drill, anti-pick cylinder
- Double stainless steel ball locking
- Anti-drill sliding cover plate design
- Clever shackle change design [Patented]
- Two keys per lock
- KA, MK & GMK available

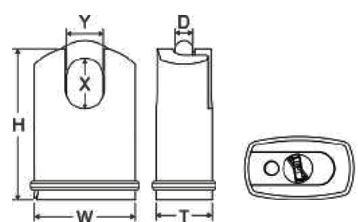
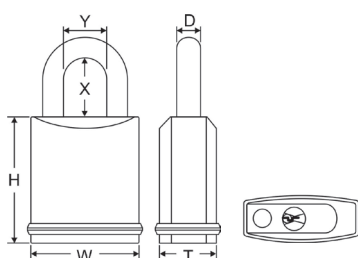

Item #	DIMENSION(MM)						Keyway
	Lock Body			Shackle			
	W	H	T	D	X	Y	
710BCR	46	49	28	8.0	25	20	R0
720BCR	54	49	30	9.5	25	20	
730BCR	61	61	32	11.0	26	31	
Shrouded Type							
710PBCR	46	80	28	8.0	25	20	
720PBCR	54	80	30	9.5	27	20	
730PBCR	61	87	32	11.0	27	23	

* Each Item# includes several shackle dimension (X): 25 , 50, 76 (mm)
Such as: 710BCR/25, 720BCR/50, 730BCR/76

710BCRSL /710PBCRSL



Description ▼

710BCRSL Series features a satin chrome plated solid brass lock body molybdenum shackle to resist corrosion and bolt cutter attack. With the blue bumper, the lock body can prevent damage to locked item. The anti-drill sliding cover plate provides high standard drilling resistance in cooperation with slide-in slot and anti-drill plate. The patented clever shackle interchange design allows to change the shackle conveniently by using simple tools. This lock adopts a non-key retaining design. The user can pull the key out with the shackle open or closed, so key can be brought with the user without risk of losing it. The spring-loaded shackle makes the lock easier to use and let the user visually tell if the lock is unlocked or locked. The double locking ball bearings increase tensile strength to resist pulling attack.

Application ▼

This lock is ideal for coastal facilities, such as beach lockers, shops, sheds, etc.

Features ▼

- Satin chrome plated solid brass lock body with blue bumper
- Anti-cut molybdenum shackle
- Rekeyable & changeable 6 pin brass anti-bump, anti-drill, anti-pick cylinder
- Double stainless steel ball locking
- Anti-drill sliding cover plate design
- Clever shackle change design [Patented]
- Non-key retaining, with shackle spring design and two keys
- KA, MK & GMK available

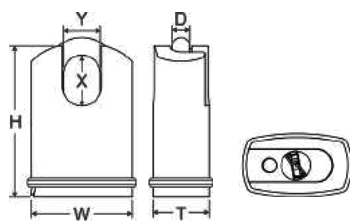
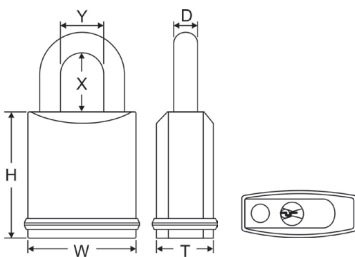

Item #	DIMENSION(MM)						Keyway
	Lock Body			Shackle			
	W	H	T	D	X	Y	
710BCRSL	46	49	28	8.0	25	20	R0
720BCRSL	54	49	30	9.5	25	20	
730BCRSL	61	61	32	11.0	26	31	
Shrouded Type							
710PBCRSL	46	80	28	8.0	25	20	
720PBCRSL	54	80	30	9.5	27	20	
730PBCRSL	61	87	32	11.0	27	23	

* Each Item# includes several shackle dimension (X): 25, 50, 76 (mm)
Such as: 710BCRSL/25, 720BCRSL/50, 730BCRSL/76

90 Series



Description ▼

90 Series features a satin chrome plated solid steel lock body with molybdenum shackle to resist drilling, sawing, twisting and brute force attacks.

The patented clever shackle interchange design allows to change the shackle conveniently by using simple tools. A set screw will be attached with each lock for changing the padlock to key retaining. The double locking ball bearings increase tensile strength to resist pulling attack.

Application ▼

This lock is ideal for security gates, lockers, warehouses, etc.

Features ▼

- Satin chrome plated solid steel lock body
- Anti-cut molybdenum shackle
- Rekeyable & changeable 6 pin brass anti-bump, anti-drill & anti-pick cylinder with two keys
- Double stainless steel ball locking
- Each lock includes a set screw for changing to key retaining
- Clever shackle change design [Patented]
- KA, MK & GMK available

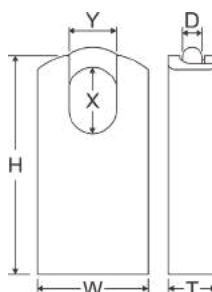
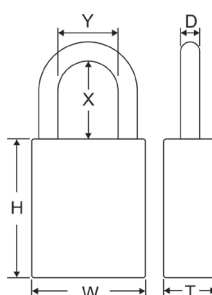

Item #	DIMENSION(MM)						Keyway
	Lock Body			Shackle			
	W	H	T	D	X	Y	
90	38	46	19	6.3	25	20	R0
100	45	46	19	8.0	25	20	
200	50	46	19	9.5	25	20	
300	63.5	52	25	11.0	30	32	
Shrouded Type							
90P	38	73	19	6.3	26	19	
100P	45	76	19	8.0	27	19	
200P	50	84	19	9.5	27	20	
300P	63.5	91	25	11.0	28	21	

* Item# 90/100/200 includes several shackle dimension (X): 25 , 50, 76 (mm)
Such as: 90/25, 100/50, 200/76

* Item# 300 includes several shackle dimension (X): 30 , 50, 76 (mm)
Such as: 300, 300/50, 300/76

95 Series



Description V

95 Series features a solid brass lock body with molybdenum shackle to resist corrosion and bolt cutter attack.

The patented clever shackle interchange design allows to change the shackle conveniently by using simple tools. A set screw will be attached with each lock for changing the padlock to key retaining. The double locking ball bearings increase tensile strength to resist pulling attack.

Application V

This lock is ideal for coastal facilities, such as beach lockers, shops, sheds, etc.

Features V

- Solid brass lock body
- Anti-cut molybdenum shackle
- Rekeyable & changeable 6 pin brass anti-bump, anti-drill & anti-pick cylinder with two keys
- Double stainless steel ball locking
- Each lock includes a set screw for changing to key retaining
- Clever shackle change design [Patented]
- KA, MK & GMK available

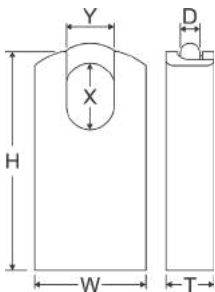
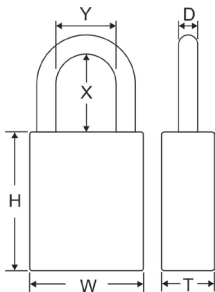

Item #	DIMENSION(MM)						Keyway
	Lock Body			Shackle			
	W	H	T	D	X	Y	
95	38	46	19	6.3	26	20	R0
150	45	46	19	8.0	25	20	
250	50	46	19	9.5	25	20	
350	63.5	52	25	11.0	30	32	
Shrouded Type							
95P	38	76	19	6.3	26	19	
150P	45	76	19	8.0	27	19	
250P	50	84	19	9.5	27	20	
350P	63.5	91	25	11.0	28	21	

* Item# 95/150/250 includes several shackle dimension (X): 25, 50, 76 (mm)

Such as: 90/25, 150/50, 250/76

* Item# 350 includes several shackle dimension (X): 30, 50, 76 (mm)

Such as: 350, 350/50, 350/76

HS40 Series



Description ▼

HS40 Series features a solid brass lock body with molybdenum shackle to resist corrosion and bolt cutter attack.

A set screw will be attached with each lock for changing the padlock to key retaining. The double locking ball bearings increase tensile strength to resist pulling attack.

Application ▼

This lock is ideal for cabinets, security gates, management environment, et.

Features ▼

- Solid brass lock body
- Anti-cut molybdenum shackle
- Rekeyable & changeable 6 pin brass anti-bump, anti-drill & anti-pick cylinder
- Double stainless steel ball locking
- Each lock includes two keys and a set screw for changing to key retaining
- KA, MK & GMK available

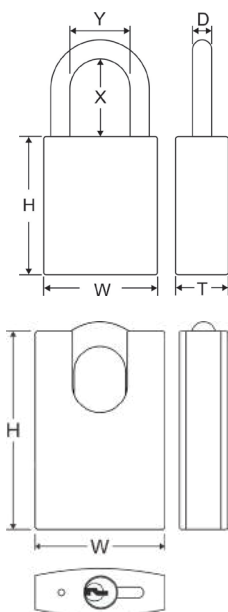

Item #	DIMENSION(MM)						Keyway
	Lock Body			Shackle			
	W	H	T	D	X	Y	
HS40	40	46	15	7.93	19	22	R0
HS45	45	46	16	8.8	23.4	20	
HS50	50	46	17	9.5	25	20	
HS60	60	52	19	11.1	25	31	
HS70	70	62	20	14	30	29	
Shrouded Type							
HS40P	40	71	15	7.93	19	22	
HS50P	50	78	17	9.5	25	20	
HS60P	60	84	19	11.1	25	31	
HS70P	70	94	20	14	30	29	

HS30 Series



Description V

HS30 Series features a solid brass lock body with stainless steel shackle to resist corrosion and adverse weather conditions. The double locking ball bearings increase tensile strength to resist pulling attack. This lock has more than more than 25,000 key combinations.

Application V

This lock is ideal for cabinets, security gates, management environment, et.

Features V

- Solid Brass lock body
- Stainless steel shackle
- Non- rekeyable 7 pin brass anti-bump, anti-drill, anti-pick cylinder
- Double stainless steel ball locking
- Have more than 25,000 key combinations
- Two keys per lock
- KA, MK & GMK available

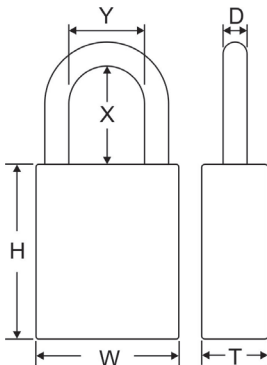

Item #	DIMENSION(MM)						Keyway
	Lock Body			Shackle			
	W	H	T	D	X	Y	
HS30	30	37	12	4.8	25	16	R0
HS30/38	30	37	12	4.8	38	16	

CYLINDER
DOOR & WINDOW LOCK
CABINET & DRAWER LOCK
PADLOCK
OTHER
PINNING & TOOLBOX
KEYBLANK

CA6CK Range Aluminium



90A



Description ▼

90A Series features a lightweight solid aluminum lock body for great portability and multiple color options can make the group management more easier. The shackle is made of hardened steel, offering outstanding resistance to cutting, sawing and twisting.

The patented clever shackle interchange design allows to change the shackle conveniently by using simple tools. A set screw will be attached with each lock for changing the padlock to key retaining. The double locking ball bearings increase tensile strength to resist pulling attack.

Application ▼

This lock is ideal for cabinets, security gates, management environment, et.

Features ▼

- Solid anodized aluminum lock body
- Hardened steel shackle
- Rekeyable & changeable 6 pin brass anti-bump, anti-drill & anti-pick cylinder with two keys
- Double stainless steel ball locking
- Each lock includes a set screw for changing to key retaining
- Clever shackle change design [Patented]
- KA & MK available

Color ▼

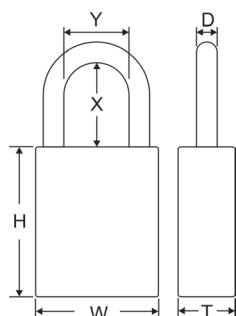

Item #	DIMENSION(MM)						Keyway
	Lock Body			Shackle			
	W	H	T	D	X	Y	
90A	38	46	19	6.3	25	20	R0
92A	38	46	19	6.3	50	20	
93A	38	46	19	6.3	76	20	
100A	45	46	19	8	25	20	
102A	45	46	19	8	50	20	
103A	45	46	19	8	76	20	
200A	50	46	19	9.5	25	20	
202A	50	46	19	9.5	50	20	
203A	50	46	19	9.5	76	20	

* Above items are available with nine color. Please add "color code" after the above Item#. Such as: 90A-BK or 100A-Y.

8102 Series



Description V

8102 Series features a quality e-coated and baking painted lock body with molybdenum shackle to resist drilling, sawing, twisting and brute force attacks.

The double locking ball bearings increase tensile strength to resist pulling attack. The quality infixed shackle seal to further protect the lock from water ingress.

Application V

This lock is ideal for security gates, factory front, garage, entrance, etc.

Features V

- Quality e-coated and baking painted lock body
- Anti-cut molybdenum shackle
- Rekeyable & changeable 6 pin brass anti-bump, anti-pick, anti-drill cylinder with two keys
- Double stainless steel ball locking
- Quality infixed shackle seal made of anti-UV PE prevents water ingress
- Rechangeable shackle design
- KA & MK available

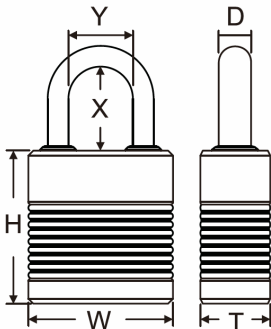

Item #	DIMENSION(MM)						Keyway
	Lock Body			Shackle			
	W	H	T	D	X	Y	
8102	44	47	27	6.35	26	19	R0
8112	44	47	27	6.93	27	19	
8103	50	47	30	9.50	27	19	
8104	63	52	31	11.1	27	31	
8105	70	60	34	14.0	30	29	

* The shackle clearance of above items is available in 2"(50mm) and 3"(76mm) shackle. Please add "50" or "76" after the above item#. For instance, 8102/38, 8103/50, or 8105/76.

8103P Series



Description ▼

8103P Series features a quality e-coated and baking painted lock body with molybdenum shackle to resist drilling, sawing, twisting and brute force attacks. Quality e-coated and baking painted shroud protects shackle from bolt cutters.

The double locking ball bearings increase tensile strength to resist pulling attack. The quality infixed shackle seal to further protect the lock from water ingress.

Application ▼

This lock is ideal for security gates, factory front, garage, entrance, etc.

Features ▼

- Quality e-coated and baking painted lock body
- Anti-cut molybdenum shackle
- Rekeyable & changeable 6 pin brass anti-bump, anti-pick, anti-drill cylinder with two keys
- Double stainless steel ball locking
- Rechangeable shackle design
- KA & MK available

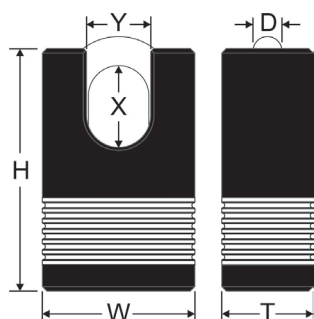

Item #	DIMENSION(MM)						Keyway
	Lock Body			Shackle			
	W	H	T	D	X	Y	
8103P	50	47	30	9.50	27	19	R0
8104P	63	52	31	11.1	27	31	

840 Series

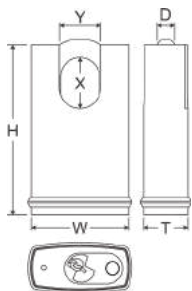
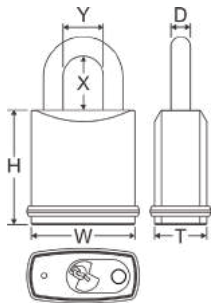

Description ▼

840 Series features a stainless steel lock body with stainless steel shackle to resist corrosion and adverse weather conditions. With the blue bumper, the lock body can prevent damage to locked item.

The patented clever shackle interchange design allows to change the shackle conveniently by using simple tools. The double locking ball bearings increase tensile strength to resist pulling attack.

Application ▼

This lock is ideal for marine and coastal facilities, such as vessels, cargo containers, beach sheds, etc.

Features ▼

- Solid stainless steel body with blue bumper
- Stainless steel shackle
- Rekeyable & changeable 6 pin brass anti-bump, anti-drill, anti-pick cylinder
- Double stainless steel ball locking
- Clever shackle change design [Patented]
- Two keys per lock
- KA, MK & GMK available



Item #	DIMENSION(MM)						Keyway	
	Lock Body			Shackle				
	W	H	T	D	X	Y		
840	39	46	20	6.3	26	20	RO	
840/50	39	46	20	6.3	50	20		
840/76	39	46	20	6.3	76	20		
845	44	46	23	7.9	27	20		
845/50	44	46	23	7.9	50	20		
845/76	44	46	23	7.9	76	20		
850	51	46	25	9.5	27	20		
850/50	51	46	25	9.5	50	20		
85076	51	46	25	9.5	76	20		
860	63	51	25	11.1	28	32		
860/50	63	51	25	11.1	50	32		
860/76	63	51	25	11.1	76	32		
Shrouded Type								
840P	39	76	20	6.3	26	20		
845P	44	76	23	7.9	27	20		
850P	51	76	25	9.5	27	20		
860P	63	85	25	11.1	28	21		



EURO Profile Padlock



EURO CYLINDER

This core is used in lock sets, deadbolts and padlocks. FEDERAL provide a feasible product range to adapt a wide variety of popular brands with the flexibility to cover numerous applications.

Solid Steel Padlock

406HE Series



Description **V**

406HE Series features a e-coated hardened steel lock body with molybdenum shackle to resist drilling, sawing, twisting and brute force attacks. With the blue bumper, the lock body can prevent damage to locked item.

This lock is suitable for 46mm half euro profile cylinders.

Application **V**

This lock is ideal for security gates, trucks, warehouses, etc. It can be used for one key system that the user can operate the door lock and the lock with one key.

Features **V**

- E-coated hardened steel lock body with blue bumper
- Anti-cut molybdenum shackle
- Suitable for 46mm half euro profile cylinders
- No core, no key

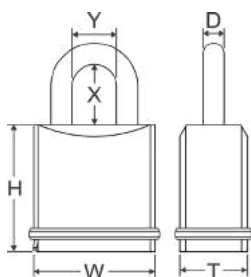

Item #	DIMENSION(MM)						Keyway
	Lock Body			Shackle			
	W	H	T	D	X	Y	
406HE	46	48	28	6.3	28	20	Without Cylinder
426HE	46	48	28	6.3	50	20	
436HE	46	48	28	6.3	76	20	
408HE	46	48	28	7.9	28	20	
428HE	46	48	28	7.9	50	20	
438HE	46	48	28	7.9	76	20	
509HE	54	49	30	9.5	28	20	
529HE	54	49	30	9.5	50	20	
539HE	54	49	30	9.5	76	20	
601HE	61	49	32	11	28	20	

* Optional adapters for different branded euro profile cylinder, please see accessory part.

Solid Brass Padlock

406BHE Series



Description V

406BHE Series features a polished solid brass lock body with molybdenum shackle to resist corrosion and bolt cutter attack. With the blue bumper, the lock body can prevent damage to locked item.

This lock is suitable for 46mm half euro profile cylinders.

Application V

This lock is ideal for coastal facilities, such as beach lockers, shops, sheds, etc. It can be used for one key system that the user can operate the door lock and the lock with one key.

Features V

- Polished solid brass lock body with blue bumper
- Anti-cut molybdenum shackle
- Suitable for 46mm half euro profile cylinders
- No core, no key

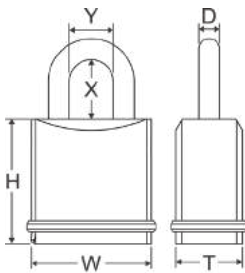

Item #	DIMENSION(MM)						Keyway
	Lock Body			Shackle			
	W	H	T	D	X	Y	
406BHE	46	48	28	6.3	28	20	Without Cylinder
426BHE	46	48	28	6.3	50	20	
436BHE	46	48	28	6.3	76	20	
408BHE	46	76	28	7.9	28	20	
428BHE	46	76	28	7.9	50	20	
438BHE	46	76	28	7.9	76	20	
509BHE	54	49	30	9.5	28	20	
529BHE	54	49	30	9.5	50	20	
539BHE	54	49	30	9.5	76	20	

* Optional adapters for different branded euro profile cylinder, please see accessory part.

CYLINDER
DOOR &
WINDOW LOCK
CABINET &
DRAWER LOCK
PADLOCK
OTHER
PINNING &
TOOLBOX
KEYBLANK

Solid Brass Padlock

406BCSHE Series



Description V

406BCSHE Series features a chrome plated solid brass lock body with stainless steel shackle for superior corrosion resistance. With the blue bumper, the lock body can prevent damage to locked item.

This lock is suitable for 46mm half euro profile cylinders.

Application V

This lock is ideal for coastal facilities, such as beach lockers, shops, sheds, etc. It can be used for one key system that the user can operate the door lock and the lock with one key.

Features V

- Chrome plated solid brass lock body with blue bumper
- Stainless steel shackle
- Suitable for 46mm half euro profile cylinder
- No core, no key

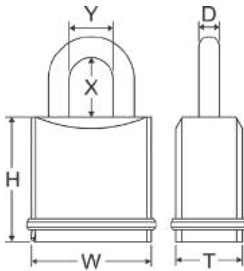

Item #	DIMENSION(MM)						Keyway
	Lock Body			Shackle			
	W	H	T	D	X	Y	
406BCSHE	46	48	28	6.3	28	20	Without Cylinder
426BCSHE	46	48	28	6.3	50	20	
436BCSHE	46	48	28	6.3	76	20	
408BCSHE	46	48	28	7.9	28	20	
428BCSHE	46	48	28	7.9	50	20	
438BCSHE	46	48	28	7.9	76	20	
509BCSHE	54	49	30	9.5	28	20	
529BCSHE	54	49	30	9.5	50	20	
539BCSHE	54	49	30	9.5	76	20	

* Optional adapters for different branded euro profile cylinder, please see accessory part.

Solid Steel Padlock

710HE Series



Description V

710HE Series features a e-coated hardened steel lock body with molybdenum shackle to resist drilling, sawing, twisting and brute force attacks. With the blue bumper, the lock body can prevent damage to locked item.

This lock is suitable for 40mm half euro profile cylinders.

Application V

This lock is ideal for security gates, trucks, warehouses, etc. It can be used for one key system that the user can operate the door lock and the lock with one key.

Features V

- E-coated hardened steel lock body with blue bumper
- Anti-cut molybdenum shackle
- Suitable for 40mm half euro profile cylinders
- No core, no key

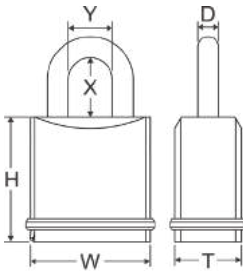

Item #	DIMENSION(MM)						Keyway
	Lock Body			Shackle			
	W	H	T	D	X	Y	
710HE/6	46	48	28	6.3	28	20	Without Cylinder
712HE/6	46	48	28	6.3	50	20	
713HE/6	46	48	28	6.3	76	20	
710HE	46	48	28	7.9	28	20	
712HE	46	48	28	7.9	50	20	
713HE	46	48	28	7.9	76	20	
720HE	54	49	30	9.5	28	20	
722HE	54	49	30	9.5	50	20	
723HE	54	49	30	9.5	76	20	

* Optional adapters for different branded euro profile cylinder, please see accessory part.

CYLINDER
DOOR &
WINDOW LOCK
CABINET &
DRAWER LOCK
PADLOCK
OTHER
PINNING &
TOOLBOX
KEYBLANK

Solid Brass Padlock

710BHE Series



Description V

Series features a polished solid brass lock body with molybdenum shackle to resist corrosion and bolt cutter attack. With the blue bumper, the lock body can prevent damage to locked item.

This lock is suitable for 40mm half euro profile cylinders.

Application V

This lock is ideal for coastal facilities, such as beach lockers, shops, sheds, etc. It can be used for one key system that the user can operate the door lock and the lock with one key.

Features V

- Polished solid brass lock body with blue bumper
- Anti-cut molybdenum shackle
- Suitable for 40mm half euro profile cylinders
- No core, no key

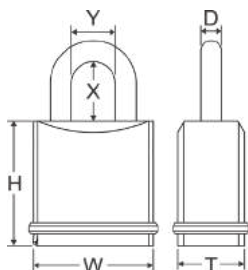

Item #	DIMENSION(MM)						Keyway
	Lock Body			Shackle			
	W	H	T	D	X	Y	
710BHE/6	46	48	28	6.3	28	20	Without Cylinder
712BHE/6	46	48	28	6.3	50	20	
713BHE/6	46	48	28	6.3	76	20	
710BHE	46	48	28	7.9	28	20	
712BHE	46	48	28	7.9	50	20	
713BHE	46	48	28	7.9	76	20	
720BHE	54	49	30	9.5	28	20	
722BHE	54	49	30	9.5	50	20	
723BHE	54	49	30	9.5	76	20	

* Optional adapters for different branded euro profile cylinder, please see accessory part.

Solid Brass Padlock

710BCSHE Series



Description V

710BCSHE Series features a chrome plated solid brass lock body with stainless steel shackle for superior corrosion resistance. With the blue bumper, the lock body can prevent damage to locked item.

This lock is suitable for 40mm half euro profile cylinders.

Application V

This lock is ideal for coastal facilities, such as beach lockers, shops, sheds, etc. It can be used for one key system that the user can operate the door lock and the lock with one key.

Features V

- Chrome plated solid brass lock body with blue bumper
- Stainless steel shackle
- Suitable for 40mm half euro profile cylinder
- No core, no key

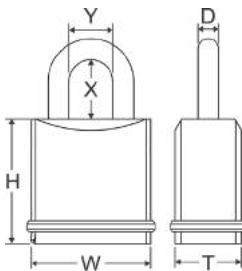

Item #	DIMENSION(MM)						Keyway
	Lock Body			Shackle			
	W	H	T	D	X	Y	
710BCSHE/6	46	48	28	6.3	28	20	Without Cylinder
712BCSHE/6	46	48	28	6.3	50	20	
713BCSHE/6	46	48	28	6.3	76	20	
710BCSHE	46	76	28	7.9	28	20	
712BCSHE	46	76	28	7.9	50	20	
713BCSHE	46	76	28	7.9	76	20	
720BCSHE	54	49	30	9.5	28	20	
722BCSHE	54	49	30	9.5	50	20	
723BCSHE	54	49	30	9.5	76	20	

* Optional adapters for different branded euro profile cylinder, please see accessory part.

CYLINDER
DOOR &
WINDOW LOCK
CABINET &
DRAWER LOCK
PADLOCK
OTHER
PINNING &
TOOLBOX
KEYBLANK

Solid Steel Padlock

730EUX /730PEUX



Description V

730EUX Series features an e-coated hardened steel lock body with molybdenum shackle to resist drilling, sawing, twisting and brute force attacks. With the blue bumper, the lock body can prevent damage to locked item. The anti-drill cover plate can provide further drilling resistance for cylinder.

The patented clever shackle interchange design allows to change the shackle conveniently by using simple tools. This lock adopts a key retaining design, when the padlock is opened, the key will be retained in the lock body until the padlock is closed again. It prevents the user from walking away with the key and leaving the padlock unlocked.

This lock is suitable for 40mm and 46mm half euro profile cylinders and related components will be provided depending on the brand of cylinder.

Application V

This lock is ideal for security gates, trucks, warehouses, etc. It can be used for one key system that the user can operate the door lock and the lock with one key.

Features V

- E-coated hardened steel lock body with blue bumper
- Anti-cut molybdenum shackle
- Suitable for half or cut-off euro profile cylinders
- Special alloy ball locking
- Anti-drill cover plate
- Clever shackle change design [Patented]
- Key retaining
- No core, no key

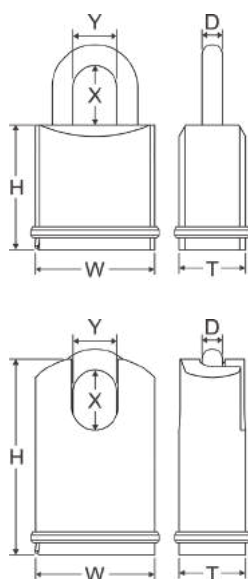

Item #	DIMENSION(MM)						Keyway
	Lock Body			Shackle			
	W	H	T	D	X	Y	
730EUX	61	76	32	11	28	32	Without Cylinder
730EUX/50	61	76	32	11	50	32	
730EUX/76	61	76	32	11	76	32	
740EUX	70	76	34	14	28	32	
740EUX/50	70	76	34	14	50	32	
740EUX/76	70	76	34	14	76	32	
Shrouded Type							
730PEUX	61	110	32	11	28	21	
740PEUX	70	110	34	14	28	21	

* Optional adapters for different branded euro profile cylinder, please see accessory part.

Solid Brass Padlock

730BEUX /730PBEUX



Description V

730BEUX Series features a polished solid brass lock body with molybdenum shackle to resist corrosion and bolt cutter attack. With the blue bumper, the lock body can prevent damage to locked item. The anti-drill cover plate can provide further drilling resistance for cylinder.

This lock adopts a key retaining design, when the padlock is opened, the key will be retained in the lock body until the padlock is closed again. It prevents the user from walking away with the key and leaving the padlock unlocked.

This lock is suitable for 40mm and 46mm half euro profile cylinders and related components will be provided depending on the brand of cylinder.

Application V

This lock is ideal for coastal facilities, such as beach lockers, shops, sheds, etc. It can be used for one key system that the user can operate the door lock and the lock with one key.

Features V

- Polished solid brass lock body with blue bumper
- Anti-cut molybdenum shackle
- Suitable for half or cut-off euro profile cylinders
- Double stainless ball locking
- Anti-drill cover plate
- Key Retaining
- No core, no key

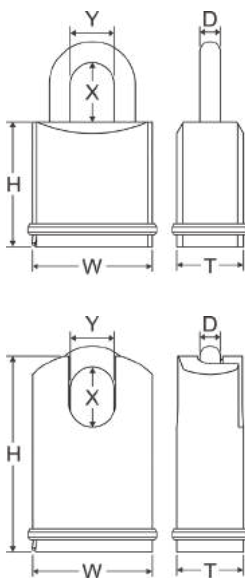

Item #	DIMENSION(MM)						Keyway
	Lock Body			Shackle			
	W	H	T	D	X	Y	
730BEUX	61	76	32	11	28	32	Without Cylinder
730BEUX/50	61	76	32	11	50	32	
730BEUX/76	61	76	32	11	76	32	
Shrouded Type							
730PBEUX	61	110	32	11	28	21	

* Optional adapters for different branded euro profile cylinder, please see accessory part.

CYLINDER
DOOR & WINDOW LOCK
CABINET & DRAWER LOCK
PADLOCK
OTHER
PINNING & TOOLBOX
KEYBLANK

Solid Brass Padlock

730BCSEUX /730PBCSEUX



Description V

730BCSEUX Series features a chrome plated solid brass lock body with stainless steel shackle for superior corrosion resistance. With the blue bumper, the lock body can prevent damage to locked item. The anti-drill sliding cover plate provides high standard drilling resistance in cooperation with slide-in slot and anti-drill plate.

This lock adopts a key retaining design. The design makes the key irremovable when unlocking to ensure locking operation is done before removing key and complies with the specifications of certificate and military uses. The double locking ball bearings increase tensile strength to resist pulling attack.

This lock is suitable for 40mm and 46mm half euro profile cylinders and related components will be provided depending on the brand of cylinder.

Application V

This lock is ideal for coastal facilities, such as beach lockers, shops, sheds, etc. It can be used for one key system that the user can operate the door lock and the lock with one key.

Features V

- Chrome plated solid brass lock body with blue bumper
- Stainless steel shackle
- Suitable for half or cut-off euro profile cylinders
- Double stainless ball locking
- Anti-drill cover plate
- Key Retaining
- No core, no key

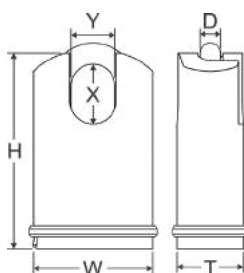
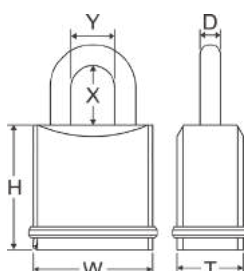

	DIMENSION(MM)						Keyway
	Lock Body			Shackle			
	W	H	T	D	X	Y	
730BCSEUX	61	76	32	11	28	32	Without Cylinder
730BCSEUX/50	61	76	32	11	50	32	
730BCSEUX/76	61	76	32	11	76	32	
Shrouded Type							
730PBCSEUX	61	110	32	11	28	21	

* Optional adapters for different branded euro profile cylinder, please see accessory part.

Stainless Steel Padlock Lock

860EUX



Description V

860EUX Series features a stainless steel lock body with stainless steel shackle to resist corrosion and adverse weather conditions. With the blue bumper, the lock body can prevent damage to locked item.

The double locking ball bearings increase tensile strength to resist pulling attack.

Application V

This lock is ideal for marine and coastal facilities, such as vessels, cargo containers, beach sheds, etc.

Features V

- Solid stainless steel body with blue bumper
- Stainless steel shackle
- Double stainless steel ball locking
- Without Cylinder Assembled

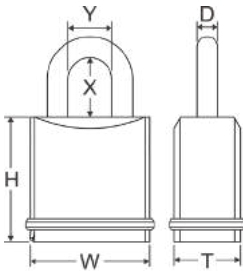

Item #	DIMENSION(MM)						Keyway
	Lock Body			Shackle			
	W	H	T	D	X	Y	
860EUX	64	64	25	11.1	26	32	Without Cylinder
860EUX/50	64	64	25	11.1	51	32	
860EUX/76	64	64	25	11.1	77	32	

* Optional adapters for different branded euro profile cylinder, please see accessory part.

High Duty Rectangular Solid Steel Padlock

731EUX /731DSEUX



Description V

731EUX /741EUX Series features a e-coated hardened steel lock body with molybdenum shackle to resist drilling, sawing, twisting and brute force attacks. The rectangular design limits the spacing and blocks the access to blot cutter wehn the lock is in place.

This lock adopts a key retaining design. The design makes the key irremovable when unlocking to ensure locking operation is done before removing key and complies with the specifications of certificate and military uses.

Both single and double slot options are available and can be used in accordance with chains or hasps.

This lock is suitable for 40mm and 46mm half euro profile cylinders and related components will be provided depending on the brand of cylinder.

Application V

This lock is ideal for security warehouse, factory gates, lorries etc. It can be used for one key system that the user can operate the door lock and the lock with one key.

Features V

- E-coated hardened steel lock body
- Anti-cut molybdenum shackle
- Suitable for half or cut-off euro profile cylinder
- Stainless steel ball locking
- Available in single and double slot options
- Key retaining
- No core, no key

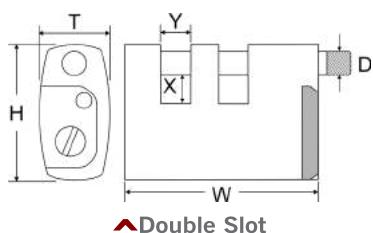
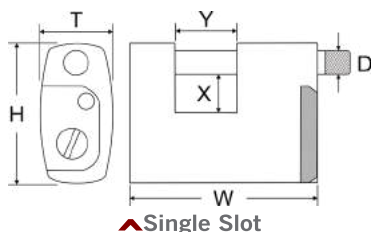

Item #	DIMENSION(MM)						Keyway	
	Lock Body			Shackle				
	W	H	T	D	X	Y		
Single Slot								
731EUX	99	61	32	10	12	27	Without Cylinder	
741EUX	125	70	34	12	21	48		
Double Slot								
731DSEUX	112	61	32	10	12	13		
741DSEUX	125	70	34	12	21	15		

* Optional adapters for different branded euro profile cylinder, please see accessory part.

Non-rekeyable Padlock



NON REKEYABLE Brass



SXD Series



Description V

A light security solid brass padlock usage of inner, such as room door, cupboard, or expanding to indoor simple equipment

Features V

- Lever locking mechanism
- Multiple shackle material options
- Anti-bump, anti-pick, and anti-drill brass cylinder
- Shackle seal for avoiding water sinking in
- Two hardened steel pins
- Two keys per lock

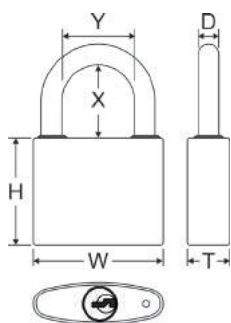

Item #	DIMENSION(MM)						Keyway
	Lock Body			Shackle			
	W	H	T	D	X	Y	
Without Shackle Seal							
X20	21	20	11	3.7	13	10	R79
With Shackle Seal							
SXD30	30	27	11	4.8	16	15	R75
SXD40	40	33	13	6.35	22	22	
SXD50	50	40	14	7.93	30	28	
SXD60	60	42	15	8.8	27	32	
SXD70	70	42	16	9.5	33	35	

Note1. The material of above Items are available with Molybdenum (R), Stainless steel (S), Brass (B). Also, the shackle clearance of above Items is available with 2" (50) and 3" (76) shackle.

Note2. Please add "shackle material code & shackle clearance" after the above Item#. Such as: SXD30R/50, SXD30S/50, or SXD30B/50.

SF Series



Description V

A security solid brass padlock with multiple shackle materials assembling in and usage of inner/outside, such as room door, cupboard, storage sheds, warehouse door, bicycle shed, or expanding to indoor/outdoor simple equipment.

Features V

- Double lever locking mechanism
- Two hardened steel pins
- Multiple shackle material options
- Shackle seal for avoiding water sinking in
- Two keys per lock
- With bumper to protect lock body

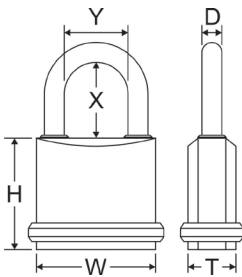

Item #	DIMENSION(MM)						
	Lock Body			Shackle			Keyway
	W	H	T	D	X	Y	
Without Heat Treatment							
F20	21	20	11	3.7	13	10	R79
With Shackle Seal							
SF30	30	28	12	5.0	19	16	R79
SF35	35	33	15	5.5	22	22	R82
SF40	40	33	15	6.3	22	22	R75
SF45	45	37	16	7.1	25	25	
SF50	50	40	17	7.9	30	28	R76
SF60	60	42	19	9.5	34	35	
SF70	70	48	21	12	38	38	

Note1. The material of above Items are available with Molybdenum (R), Stainless steel (S), Brass (B).

Also, the shackle clearance of above Items is available with 2" (50) and 3" (76) shackle.

Note2. Please add "shackle material code & shackle clearance" after the above Item#.

Such as: SF30R/50, SF30S/50, or SF30B/50.

NON REKEYABLE Brass



F_E Series



Description V

A security solid brass padlock with cover to have whole protection of lock body and usage of outside, such as storage sheds, warehouse door, bicycle shed, or expanding to indoor/outdoor simple equipment.

Features V

- Lever locking mechanism
- Multiple shackle material options
- Two keys per lock
- PE cover to protect valuable surface

Color V

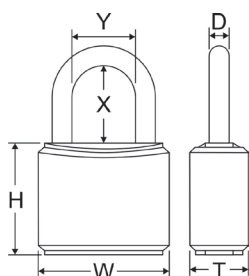

Item #	DIMENSION(MM)						Keyway
	Lock Body			Shackle			
	W	H	T	D	X	Y	
Without Heat Treatment							
F15E	18	18	12	3.1	12	7	R78
F20E	23	20	13	3.7	13	10	R5
F25E	28	26	15	4	17	16	
With Heat Treatment							
F30E	33	28	16	5.0	20	16	R79
F35E	38	33	18	5.4	22	22	R82
F40E	44	34	19	6.3	23	22	R75
F45E	48	37	19	7.1	25	25	
F50E	54	40	21	7.9	30	28	R76

Note1. The material of above Items are available with Molybdenum (R), Stainless steel (S), Brass (B). Also, the shackle clearance of above Items is available with 2" (50) and 3" (76) shackle.

Note2. Please add "shackle material code & shackle clearance" after the above Item#. Such as: F30ES or F30EB.

Note3. Please add "shackle clearance & color code" after the above Item#. Such as: F35E/38-BK, or F50E/54-GN.

F_C Series



Description V

A security solid brass padlock with cover to have whole protection of lock body and usage of outside, such as storage sheds, warehouse door, bicycle shed, or expanding to indoor/outdoor simple equipment.

Features V

- Lever locking mechanism
- Multiple shackle material options
- Two keys per lock
- With PE cover to protect valuable surface

Color V

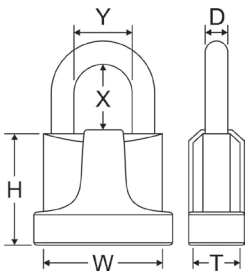
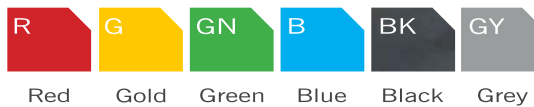

Item #	DIMENSION(MM)						Keyway
	Lock Body			Shackle			
	W	H	T	D	X	Y	
F30C	32	30	14	5	18	16	R79
F40C	42	35	15	6.3	21	22	R75
F50C	52	42	19	7.9	29	28	R76

Note1. The material of above Items are available with Molybdenum (R), Stainless steel (S), Brass (B). Also, the shackle clearance of above Items is available with 2" (50) and 3" (76) shackle.

Note2. Please add "shackle material code & shackle clearance" after the above Item#. Such as: F30CS or F30CB.

Note3. Please add "shackle clearance & color code" after the above Item#. Such as: F30C-BK

NON REKEYABLE Brass



Shrouded Shackle Series



Description V

A security solid brass padlock with shrouded shackle protection design and usage of outside, such as storage sheds, warehouse door, bicycle shed, or expanding to indoor/outdoor simple equipment.

Features V

- Solid brass lock body with shackle protect design
- Molybdenum shackle
- Precision pin tumbler brass cylinder
- Lever locking mechanism
- Quality PVC bumper protect surface
- Two keys per lock

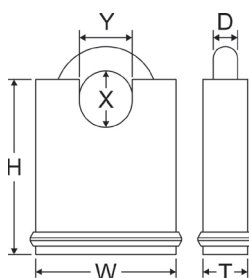

Item #	DIMENSION(MM)						Keyway
	Lock Body			Shackle			
	W	H	T	D	X	Y	
30P	30	40	10	5	15	12	R79
40P	40	50	10	7	20	14	R75
50P	50	62	12	8.7	20	19	R76
60P	60	74	18.7	9.5	35	20	

Note1. The material of above Items are available with Molybdenum (R), Stainless steel (S), Brass (B). Also, the shackle clearance of above Items is available with 2" (50) and 3" (76) shackle.

Note2. Please add "shackle material code & shackle clearance" after the above Item#. Such as: F30ES or F30EB.

Note3. Please add "shackle clearance & color code" after the above Item#. Such as: F35E/38-BK, or F50E/54-GN.

Fed Series



Description V

A high security solid brass padlock and usage of outside, such as storage sheds, warehouse door, bicycle shed, or expanding to indoor/outdoor simple equipment.

Features V

- Lever locking mechanism
- Precision pin tumbler brass cylinder
- Multiple shackle material options
- Two keys with per lock

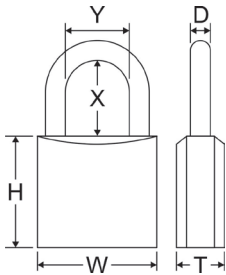

Item #	DIMENSION(MM)						
	Lock Body			Shackle			Keyway
	W	H	T	D	X	Y	
Without Heat Treatment							
Fed20	20	20	11	3.7	11	10	R79
With Heat Treatment							
Fed30	30	28	13	5	19	16	R82
Fed40	40	33	15	6.3	23	22	R75
Fed50	50	40	17	7.9	30	28	R76
Fed60	60	42	19	9.5	29	32	
Fed70	70	48	21	12	38	38	

Note1. The material of above Items are available with Molybdenum (R), Stainless steel (S), Brass (B).

Also, the shackle clearance of above Items is available with 2" (50) and 3" (76) shackle.

Note2. Please add "shackle material code & shackle clearance" after the above Item#.

CYLINDER
DOOR & WINDOW LOCK
CABINET & DRAWER LOCK
PADLOCK
OTHER
PINNING & TOOLBOX
KEYBLANK

NON REKEYABLE Brass



M Series



Description V

A high security solid brass padlock and usage of outside, such as storage sheds, warehouse door, bicycle shed, or expanding to indoor/outdoor simple equipment.

Features V

- Lever locking mechanism
- Precision pin tumbler brass cylinder
- Hardened steel shackle
- Two keys per lock

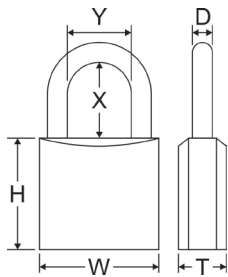

Item #	DIMENSION(MM)						
	Lock Body			Shackle			Keyway
	W	H	T	D	X	Y	
Without Heat Treatment							
M20	21	20	11	3.7	11	10	R79
With Heat Treatment							
M30	30	28	13	5	16	16	R82
M40	40	33	15	6.3	22	22	R75
M50	50	40	17	7.9	26	26	R76
M60	60	42	19	9.5	29	32	
M70	70	48	21	12	38	38	

ER Series



Description V

A security solid brass padlock with multiple shackle materials assembling in and usage of inner/outside, such as storage sheds, warehouse door, bicycle shed, or expanding to indoor/outdoor simple equipment.

Features V

- Lever locking mechanism
- Multiple shackle material options
- Precision pin tumbler brass cylinder
- Two keys per lock

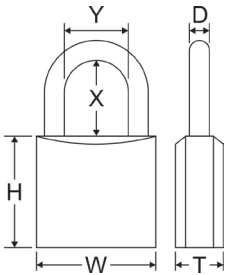

Item #	DIMENSION(MM)						Keyway
	Lock Body			Shackle			
	W	H	T	D	X	Y	
ER20	21.0	23.5	11.5	3.7	13	10	7C
ER25	25.0	26.5	12.0	4	13	16	6C
ER30	30.0	30.0	13.0	5.0	18	16	10C
ER35	35.0	33.0	14.0	5.5	18	18	9C
ER40	40.3	34.0	15.3	6.3	22	22	
ER45	44.9	35.5	15.5	7.1	24	25	3C
ER50	50.0	40.0	17.0	7.9	30	28	
ER60	60.0	42.0	19.0	9.5	33	35	
ER70	69.5	48.3	21.0	12	38	38	

Note1. The material of above Items are available with Stainless steel (S), Brass (B).
 Also, the shackle clearance of above Items is available with 2" (50) and 3" (76) shackle.
 Note2. Please add "shackle material code & shackle clearance" after the above Item#.
 Such as: F30S or F50B.

NON REKEYABLE Rectangular Solid Brass Padlock



F600 Series



Description V

A high security rectangular brass padlock with hardened shackle usage of outside, such as storage sheds, warehouse door, bicycle shed, or expanding to indoor/outdoor simple equipment.

Features V

- Solid brass lock body
- Lever locking mechanism
- Precision pin tumbler brass cylinder
- Hardened steel shackle with quality plating
- Two keys per lock

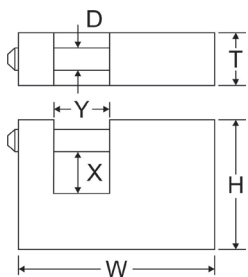

Item #	DIMENSION(MM)						Keyway
	Lock Body			Shackle			
	W	H	T	D	X	Y	
F605	56	36	15	6.3	11	16	R7
F606	63	43	16	10	12	18	
F607	76	48	18	11	14	24	
F608	85	55	19	12	16	30	

SXD_NPS Series



Description V

A security solid brass padlock with US32D coated and usage of inner, such as room door, cupboard, or expanding to indoor simple equipment.

Features V

- Brass lock body with US32D plated
- Double lever locking mechanism
- Anti-bump, anti-pick, and anti-drill brass cylinder
- Two hardened steel pins
- Stainless steel shackle material options
- Shackle seal for avoiding water sinking in
- Two keys per lock

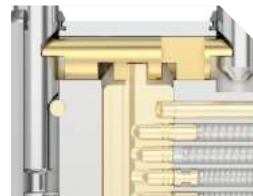
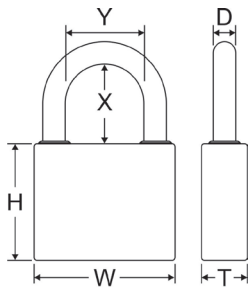

▲ Double lever system



Item #	DIMENSION(MM)						
	Lock Body			Shackle			Keyway
	W	H	T	D	X	Y	
Without Shackle Seal							
X20NPS	21	20	11	3.7	13	10	R79
With Shackle Seal							
SXD30NPS	30	27	11	4.8	16	15	R79
SXD40NPS	40	33	13	6.35	26	22	R75
SXD50NPS	50	40	14	7.93	30	28	
SXD60NPS	60	42	15	8.8	27	32	
SXD70NPS	70	42	16	9.5	33	35	

CYLINDER
 DOOR & WINDOW LOCK
 CABINET & DRAWER LOCK
 PADLOCK
 OTHER
 PINNING & TOOLBOX
 KEYBLANK

NON REKEYABLE US32D



SXD_NPS-KR Series



Description V

A security solid brass padlock with US32D coated and usage of inner, such as room door, cupboard, or expanding to indoor simple equipment.

Features V

- Brass lock body with US32D plated
- Ball bearing locking system
- Key retaining
- Anti-bump, anti-pick, and anti-drill brass cylinder
- Two hardened steel pins
- Stainless steel shackle material options
- Shackle seal for avoiding water sinking in
- Two keys per lock

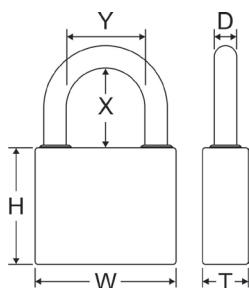

▲ Ball bearing system

Item #	DIMENSION(MM)						Keyway
	Lock Body			Shackle			
	W	H	T	D	X	Y	
SXD30NPS-KR	30	30	12	5	16	16	R79
SXD40NPS-KR	40	35	14	6	26	20	R75
SXD50NPS-KR	50	37	15	8	20	20	

SF_NPS Series



Description V

A high security solid brass padlock with multiple shackle materials assembling in and Satin Nickel coated, and usage of inner/outside, such as room door, cupboard, storage sheds, warehouse door, bicycle shed, or expanding to indoor/outdoor simple equipment.

Features V

- Brass lock body with Satin Nickel plated
- Double lever locking mechanism
- Non-key retaining
- Anti-bump, anti-pick, and anti-drill brass cylinder
- Two hardened steel pins
- Stainless steel shackle material options
- Shackle seal for avoiding water sinking in
- Two keys per lock

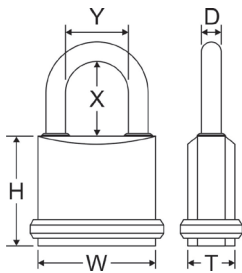

Item #	DIMENSION(MM)						Keyway
	Lock Body			Shackle			
	W	H	T	D	X	Y	
Without Shackle Seal							
F20NPS	21	20	11	3.7	13	10	R79
With Shackle Seal							
SF30NPS	30	28	12	5	19	16	R79
SF35NPS	35	33	14	5.5	22	22	R82
SF40NPS	40	33	15	6.3	22	22	R75
SF45NPS	45	37	16	7.1	25	25	
SF50NPS	50	40	17	7.9	30	28	R76
SF60NPS	60	42	19	9.5	34	35	
SF70NPS	70	48	21	12	38	38	

Note. The shackle clearance is available with 2" (50) and 3" (76) shackle. Please add "shackle clearance" after the above Item#. Such as: SF30NPS/50 or SF30NPS/76

NON REKEYABLE A Plus Padlock



8000 Series



Description V

8000 Series features a high level lock body and shackle for high secure usage and usage of inner/outside, such as room door, cupboard, storage sheds, warehouse door, bicycle shed or expanding to indoor/outdoor simple equipment.

Features V

- Quality electric coated and powder coated body
- Anti-bump, anti-pick, anti-drill cylinder
- 5 & 6 pin brass cylinder
- Anti-cut molybdenum shackle
- Quality infixes shackle seal made of anti-UV PE for avoiding water sinking in
- Double stainless steel ball locking
- Two keys per lock

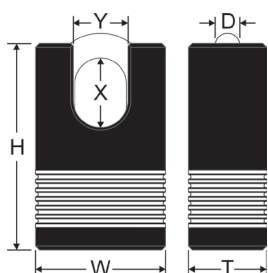
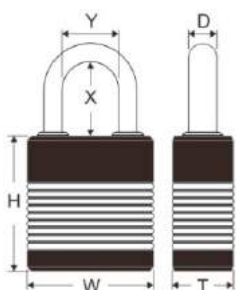

^Shrouded



Item #	DIMENSION(MM)						Keyway
	Lock Body			Shackle			
	W	H	T	D	X	Y	
8002	44	47	27	6.35	26	19	Note 1.
8012	44	47	27	7.93	27	19	
8003	50	47	30	9.50	27	19	
8004	63	52	31	11.1	27	31	
8005	70	60	34	14	30	29	
Shrouded Type							
8003P	50	47	30	9.5	27	19	
8004P	63	52	31	11.1	27	31	

Note1. USA Market standard keyway: 4R147 / 5R149. Europe Market standard keyway: 5R0.
Also available for customer's special keyway

Note2. The shackle clearance of above items is available in 1.5"(38mm) \ 2"(50mm) and 3"(76mm) shackle.

Note3. Please add "50" or "76" after the above item#. For instance, 8002/38, 8003/50, or 8002/76.

800WN Series



Description V

A security laminated padlock with cover to protect lock body and raise applied range, and usage of outside, such as storage sheds, warehouse door, bicycle shed, or expanding to indoor/outdoor simple equipment.

Features V

- Laminated lock body with quality plating
- Anti-cut molybdenum shackle and PVC cover
- Double stainless steel ball locking
- Anti-bump, anti-pick, anti-drill pin brass cylinder
- Two keys per lock
- Sliding plastic bottom plate
- Quality PVC cover to protect valuable surface, with multiple color options for managing easily

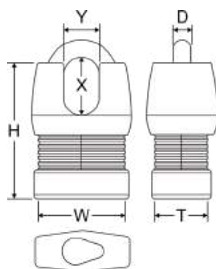
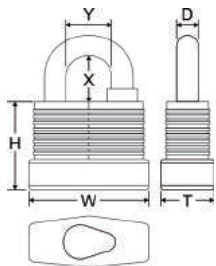

Color V



Item #	DIMENSION(MM)						Keyway
	Lock Body			Shackle			
	W	H	T	D	X	Y	
802WN	45	41	28	8.7	18	18	Note1
803WN	55	44	31	11.4	21	22	
804WN	70	51	36	13.7	28	29	
With Shackle Seal							
802WNP	45	47	28	8.1	18	18	Note1
803WNP	55	84	31	11	23	22	
804WNP	70	98	36	13.7	30	29	

Note1. USA Market standard keyway: 4R147 / 5R149. Europe Market standard keyway: 5R0. Also available for customer's special keyway

Note2. The shackle clearance of above items is available in 1.5"(38mm) 、2"(50mm) and 3"(76mm) shackle.

Note3. Please add "shackle clearance & color code" after the above Item#. Such as: 802WN/38-BK, or 804WN/50-GN.

NON REKEYABLE Laminated



EL800 Series



Description V

A security laminated padlock with cover to protect lock body and raise applied range, and usage of outside, such as storage sheds, warehouse door, bicycle shed, or expanding to indoor/outdoor simple equipment.

Features V

- Advanced anti-corrosion design surpassing other standard laminated padlocks
- Anti-cut molybdenum shackle
- Shackle seal for avoiding water sinking in(except EL801)
- Double stainless steel ball locking except for EL801
- Anti-bump, anti-pick, anti-drill pin brass cylinder
- Two keys per lock
- Quality PVC cover to protect valuable surface

Color V

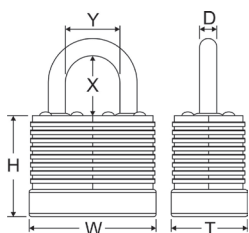

Item #	DIMENSION(MM)						
	Lock Body			Shackle			Keyway
	W	H	T	D	X	Y	
Without Shackle Seal							
EL801	35	26	17	5.2	18	14	4R148
With Shackle Seal							
SEL802	45	37	28	6.3	21	20	Note1
SEL812	49	37	28	7	24	21.5	
SEL803	55	40	31	8.8	26	24.1	

Note1. USA Market standard keyway: 4R147 / 5R149. Europe Market standard keyway: 5R0.
Also available for customer's special keyway

Note2. The shackle clearance of above Items is available with 1 1/2" (38mm) and 2" (50mm) shackle.

Note3. Please add "shackle clearance & color code" after the above Item#. Such as: EL801/38-BK, or SEL803/50-GN.

NON REKEYABLE Laminated

S800 Series

Description V

A high security steel laminated padlock with triangle cover to have economical and practical and usage of outside, such as storage sheds, warehouse door, bicycle shed, or expanding to indoor/outdoor simple equipment.



Features V

- Laminated lock body
- Anti-cut molybdenum shackle
- Double stainless steel ball locking except for S801
- Anti-bump, anti-pick, anti-drill brass cylinder
- Two keys per lock
- Triangle PE bumper to protect valuable surface

Color V

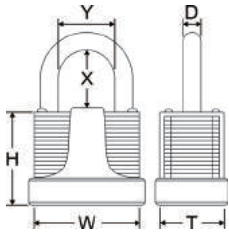

Item #	DIMENSION(MM)						Keyway
	Lock Body			Shackle			
	W	H	T	D	X	Y	
S801	31	26	17	5.2	17	14	4R148
S802	40	36	26	6.3	22	20	Note 1
S812	44	36	31	7	25	21.5	
S803	50	39	26	8.8	25	24.5	
S804	65	44	31	11	32	32	

Note1. USA Market standard keyway: 4R147 / 5R149. Europe Market standard keyway: 5R0.

Also available for customer's special keyway

Note2. The shackle clearance of above Items is available with 1.5" (38mm) and 2" (50mm) shackle.

Note3. Please add "shackle clearance & color code" after the above Item#. Such as: S802/38-BK, or S804/50-GN

NON REKEYABLE Laminated



800 Series



Description V

A security steel laminated padlock have economical and practical and usage of inner, such as room door, cupboard, or expanding to indoor simple equipment.

Features V

- Laminated lock body with quality plating
- Anti-cut molybdenum shackle
- Double stainless steel ball locking except for 801
- Anti-bump, anti-pick, anti-drill 4 or 5 pin brass cylinder
- Two keys per lock
- PE bumper to protect valuable surface

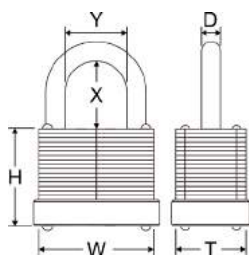

Item #	DIMENSION(MM)						Keyway
	Lock Body			Shackle			
	W	H	T	D	X	Y	
801	31	26	17	5.2	17	14	4R148
802	40	36	26	6.3	22	20	Note 1
812	44	36	31	7	25	21.5	
803	50	39	26	8.8	25	24.5	
804	65	44	31	11	32	32	

Note1. USA Market standard keyway: 4R147 / 5R149. Europe Market standard keyway: 5R0.
Also available for customer's special keyway

Note2. The shackle clearance of above Items is available with 1.5" (38mm) and 2" (50mm) shackle.

800B Series

Description V

A security brass laminated padlock have usage of inner, such as room door, cupboard, or expanding to indoor simple equipment.



Features V

- Laminated lock body
- Shackle available in multiple materials
- Double stainless steel ball locking except for 801B
- Anti-bump, anti-pick, anti-drill 4 or 5 pin brass cylinder
- Two keys per lock
- PE bumper to protect surface

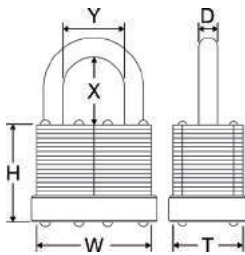

Item #	DIMENSION(MM)						Keyway
	Lock Body			Shackle			
	W	H	T	D	X	Y	
801B	31	26	17	5.2	17	14	4R148
802B	40	36	26	6.3	22	20	Note1
802BL	40	36	26	6.3	48	20	
812B	44	36	31	7	25	21.5	
812BL	44	36	31	7	48	21.5	
803B	50	39	26	8.8	25	24.5	

Note1. USA Market standard keyway: 4R147 / 5R149. Europe Market standard keyway: 5R0.
Also available for customer's special keyway

Note2. The shackle clearance of above Items is available with 1.5" (38mm) and 2" (50mm) shackle.

NON REKEYABLE Laminated



800BB Series



Description V

A security brass laminated padlock with brass material shackle have economical and practical and usage of inner, Such as room door, cupboard, or expanding to indoor simple equipment.

Features V

- Laminated lock body
- Brass shackle
- Anti-bump, anti-pick, anti-drill 4 or 5 pin brass cylinder
- Double stainless steel ball locking except for 801B is single lever
- Two keys per lock
- PE bumper to protect surface

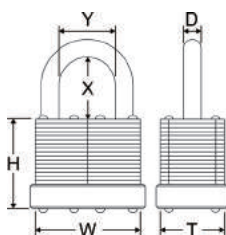

Item #	DIMENSION(MM)						Keyway
	Lock Body			Shackle			
	W	H	T	D	X	Y	
801BB	31	26	17	5.2	17	14	4R148
802BB	40	36	26	6.3	22	20	Note 1
812BB	44	36	31	7	25	21.5	
803BB	50	39	26	8.8	25	24.5	

Note1. Europe Market standard keyway: 5R0. USA Market standard keyway: 4R147 / 5R149.
 Also available for customer's special keyway

Note2. The shackle clearance of above Items is available with 1.5" (38mm) and 2" (50mm) shackle.

NON REKEYABLE Shielded shackle padlock



1000S Series



Description V

A shielded shackle stainless steel padlock and usual usage of machine and equipment locking.

Features V

- Stainless steel lock body and inside parts
- Hardened steel shackle with quality plating
- Laser welded lock body
- Precision 4 pin brass cylinder
- Two keys per lock

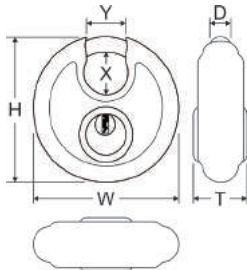

Item #	DIMENSION(MM)						Keyway
	Lock Body			Shackle			
	W	H	T	D	X	Y	
1000S	70	70	30	9.5	25	24	R11
1000DT	70	70	30	9.5	25	24	

Note. 1000S can combine with Federal's security hasp item# 1065

CYLINDER

DOOR &
WINDOW LOCK

CABINET &
DRAWER LOCK

PADLOCK

OTHER

PINNING &
TOOLBOX

KEYBLANK

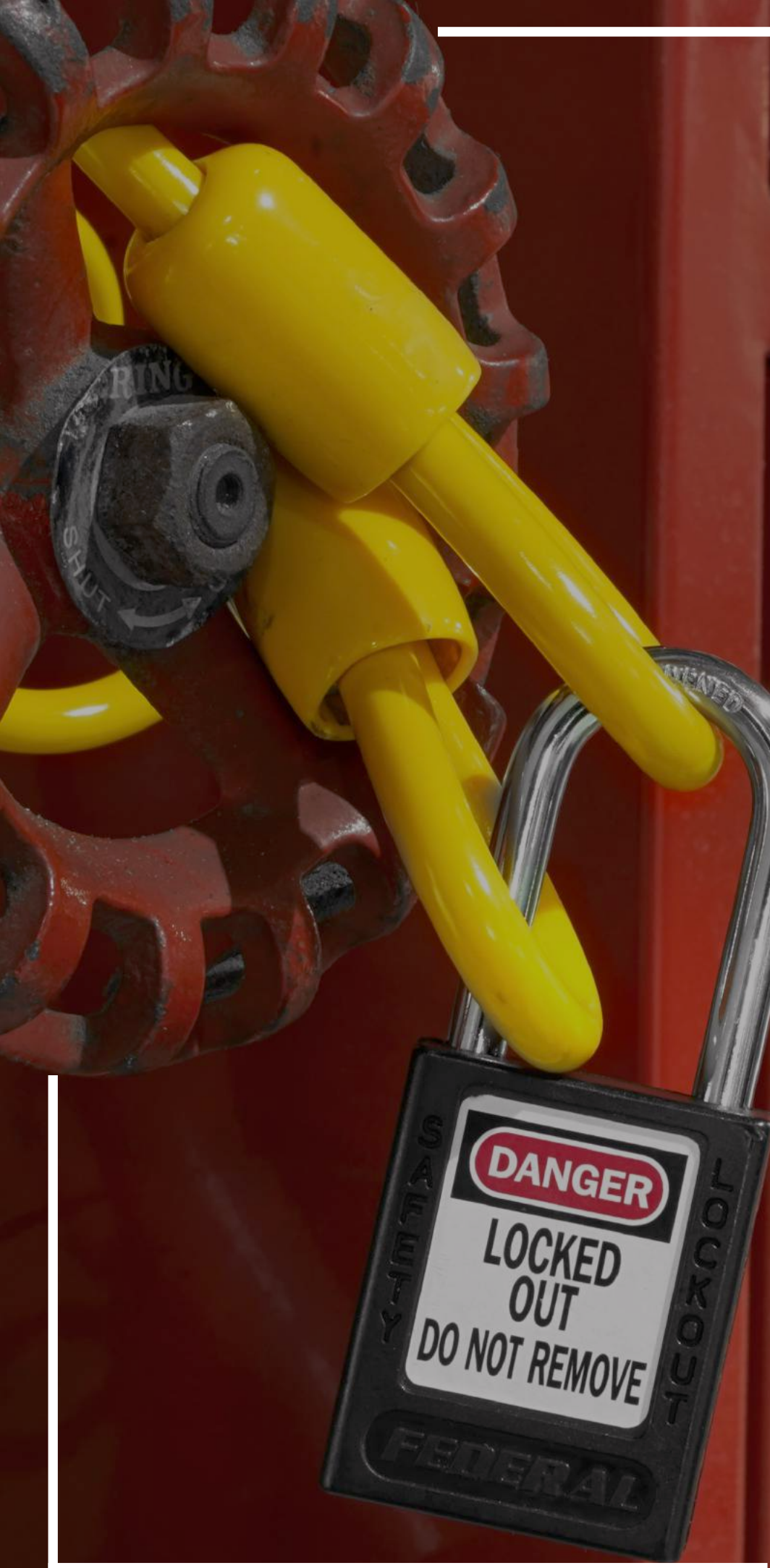

SAFETY LOCKOUT

+

SAFETY LOCKOUT

PL90



Description V

PL90 Series features a non-conductive thermoplastic lock body, shackle with multiple materials and double stainless ball locking mechanism. It provides key retaining function which ensures the padlock is not left unlocked.

Features V

- Non-conductive thermoplastic lock body
- Hardened steel, aluminum or plastic shackle
- Double stainless ball locking
- Key retaining for ensuring that padlock is not left unlocked
- 6 pin brass cylinder with 1 key
- Durable and lightweight
- Use for Lockout and Tag out application
- Write-on labels attached

Color V

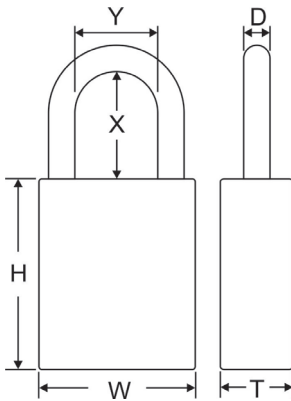
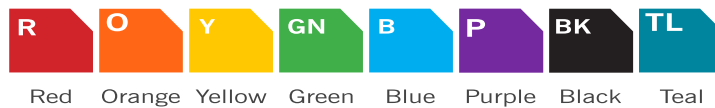

Item #	DIMENSION(MM)						Keyway
	Lock Body			Shackle			
	W	H	T	D	X	Y	
PL90	38	46	19	6.35	38	19	R0
PL90/76	38	46	19	6.35	76	19	

* Item # with "A" stands for aluminum shackle, and with "PE" stands for plastic shackle.

* Above Items are available with eight colors. Please add "color code" after the above Item#. Such as: PL90-R, PL90A/76-R.

SAFETY LOCKOUT

PL90E



Description V

PL90E Series features a non-conductive thermoplastic lock body, shackle with multiple materials and double stainless ball locking mechanism. It provides key retaining function which ensures the padlock is not left unlocked.

Features V

- Non-conductive thermoplastic lock body
- Hardened steel, aluminum or plastic shackle
- Double stainless ball locking
- Key retaining for ensuring that padlock is not left unlocked
- 6 pin brass cylinder with 1 key
- Durable and lightweight
- Use for Lockout and Tag out application
- Write-on labels attached

Color V

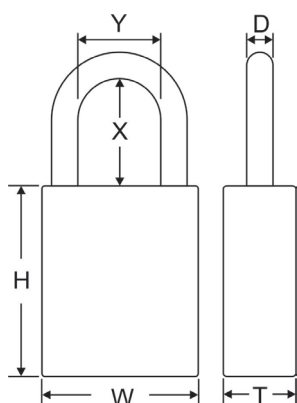
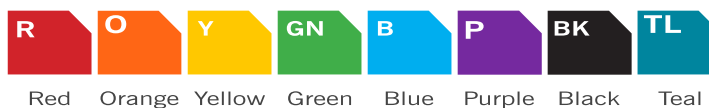

Item #	DIMENSION(MM)						
	Lock Body			Shackle			Keyway
	W	H	T	D	X	Y	
PL90PE	38	46	19	6.35	38	19	R0

* Item # with "A" stands for aluminum shackle, and with "PE" stands for plastic shackle.

* Above Items are available with eight colors. Please add "color code" after the above Item#. Such as: PL90PE-R, PL90PE/76-R.

SAFETY LOCKOUT

SLH Series



Features V

- Lockout by multiple workers at each lockout point
- Keeps facilities inoperative while repairs or adjustments are made
- Control cannot be turned on until last worker's padlock is removed from hasp
- Attach device to energy disconnect switch
- Hold up 6 locks

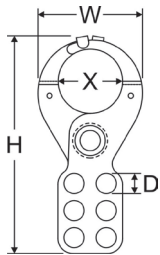

Item #	DIMENSION(MM)						Hold up Lock QTY
	W	H	D	X	Y		
SLH25	45	114	10	25	25	6	
SLH38	62	129	10	38	38		

SL Series



Features V

- Shackle type
- Hold up 7 locks
- Stainless steel lock body
- SL58: shackle open and close manually
- SL58R: automatically rebound shackle

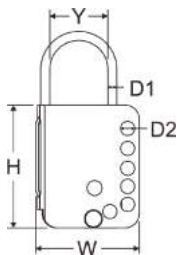

Item #	DIMENSION(MM)						Hold up Lock QTY
	W	H	D1	D2	X	Y	
SL58	58	68	5	8	32	37	7
SL58R	58	68	5	8	32	37	

CYLINDER
DOOR & WINDOW LOCK
CABINET & DRAWER LOCK
PADLOCK
OTHER
PINNING & TOOLBOX
KEYBLANK

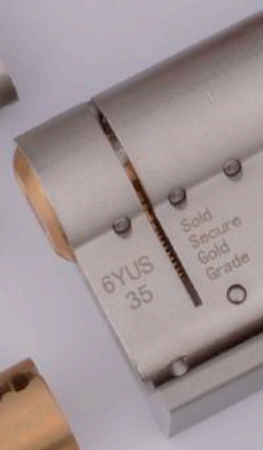



Pinning Kit & Tool Box

Pinning Kit – PL01 for CA6CK Cylinder

The pinning kit has the components you need to re-pin the cylinders. If you are looking for a durable pinning kit, you've found it! With this heavy duty metal box to keep your repinning pins, you can count on this kit every time.

Feature

- Components for CA6CK Cylinders.
- Each part contained in this kit is available as a separate item for future replenishment.
- All parts have their own compartment within the carrying case.
- 100 pcs per item.



Pinning Kit Jewelry Box

If you just require some specific components, we also provide the Pinning kit-Jewelry box. There are two size, 200 pcs or 500 pcs per box.



200 pcs per box



500 pcs per box

Noted

- Due to the size of clips, there are only 100 & 200 pcs per box.



Line	Picture	Code	Description	Line	Picture	Code	Description
1		201600000160	Bottom Pin #1 (Steel)	19		201600000166	Bottom Pin #7 (Steel)
2		201600000060	Bottom Pin #1 (Brass)	20		201600000066	Bottom Pin #7 (Brass)
3		201600000068	Bottom Pin #1 (Stainless)	21		201600000074	Bottom Pin #7 (Stainless)
4		201600000161	Bottom Pin #2 (Steel)	22		201600000167	Bottom Pin #8 (Steel)
5		201600000061	Bottom Pin #2 (Brass)	23		201600000067	Bottom Pin #8 (Brass)
6		201600000069	Bottom Pin #2 (Stainless)	24		201600000075	Bottom Pin #8 (Stainless)
7		201600000162	Bottom Pin #3 (Steel)	25		201600000287	Anti-Bumping Pin
8		201600000062	Bottom Pin #3 (Brass)	26		201500000030	Top Pin
9		201600000070	Bottom Pin #3 (Stainless)	27		201500000063	Top Pin
10		201600000163	Bottom Pin #4 (Steel)	28		201500000045	Top Pin
11		201600000063	Bottom Pin #4 (Brass)	29		201500000037	Master Pin #2
12		201600000071	Bottom Pin #4 (Stainless)	30		201500000038	Master Pin #3
13		201600000164	Bottom Pin #5 (Steel)	31		201500000039	Master Pin #4
14		201600000064	Bottom Pin #5 (Brass)	32		201500000040	Master Pin #5
15		201600000072	Bottom Pin #5 (Stainless)	33		201500000041	Master Pin #6
16		201600000165	Bottom Pin #6 (Steel)	34		201000000037	Tumbler Spring
17		201600000065	Bottom Pin #6 (Brass)	35		201000000038	Tumbler Spring
18		201600000073	Bottom Pin #6 (Stainless)				

Tool Box – TB05











for CA6CK Series cylinder

The tool box includes the necessary tools you will need to re-pin the cylinders. All tools are packed neatly in a durable heavy metal case to keep them secure clean, organized and easy to find.

Feature

- Assembly for CA6CK Cylinders.
- Each tool contained in this kit is available as a separate item for future replenishment.
- All tools have their own compartment within the carrying case.
- Keyless convenience.
- 1 piece/set per item.



Line	Picture	Code	Description
1		213000000045	Pin Tumble Changing Plate
2		213000000114	Cylinder Assembly Tool
3		21300000115	Flathead Screwdriver for Changing Cylinder of HS Series Padlock
4		200500170026~33	2 Keys -6 Pins-KB6 R0 Keyway -Nickel Plated
5		213000170396	Tool for Changing Clever Shackle
6		903030015000	1.5mm Allen Key
7		903030020001	2.0mm Allen Key
8		213000000028	2.5mm Allen Key
9		903030030001	3.0mm Allen Key
10		200300000162	Gauge
11		903041010203	Screwdriver

CYLINDER

DOOR &
WINDOW LOCK

CABINET &
DRAWER LOCK

PADLOCK

OTHER

PINNING &
TOOLBOX

KEYBLANK



**FEDERAL
LOCK**



CATALOG



Download



Contact Us



**FEDERAL
LOCK**



CATALOG



Download



Contact Us



FEDERAL LOCK CO., LTD.

**Address: 3 Jiann Gong Road, Neipu
Industrial District, Ping Tung 91252, Taiwan**

Email: federal@federallock.com.tw

Phone: 886-8-7692966

Fax: 886-8-7692885 ~6

Website: www.federallock.com.tw